

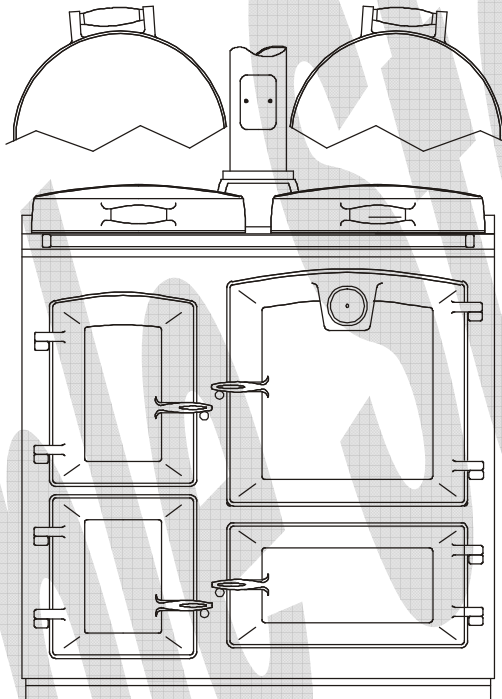

SANDYFORD COTTAGE COOKERS MARINE FITTING INSTRUCTIONS



<http://www.oilstoves.co.uk/>

Index

1 Introduction	4
2 Optional Extras	5
2.1 Remote Time Clock	5
2.2 High recovery hot water cylinder.	5
2.3 Flue Systems.	5
2.5 Pressurisation kit for NON-POTABLE water.	6
2.8 Pressurisation kit for potable water.	6
3 Modes of Operation	6
4 Installation	7
4.1 Clearances for servicing the boiler.	7
4.2 Location.	8
4-2a Clearances From Combustibles	8
4-2b Fastening Down	9
4.3 Plumbing.	9
4.4 Hot water.	10
4-4a Schematic Grundfos Twin Pump System.	11
4-4b Schematic Y Plan System.	12
4-4c Schematic S Plan	13
4.5 Power Supply 230-VOLT a.c.	13
4-5-1 Typical control either Y plan, S plan or Grundfos Pump plan.	14
4.7 Oil supply.	15
4.7.1 Schematic Oil Layout	16
4.8 Fuel Pump	17
4.9 Flueing.	17
4.10 Ventilation.	20
6 Commissioning The Boiler	20
6.1 Read this preamble Before attempting to Fire up.	20
6.2 Vent air from the boiler and heating system.	21
6.3 Commission the heating pressure system if fitted.	21
6.4 Check the heating system.	21
6.5 The effect of TRV's.	21
6.6 Check hot water system, expansion vessel and pressure release devices.	21
6.7 Checking The Flue Gas Emissions And Temperature.	22
6.8 Commissioning Check Tick List.	22
7 Routine Maintenance	23
7.1 Introduction.	23

7.2	Removing and cleaning the burner.	24
7.3	To remove and clean the flame tube.	25
7.4	To remove examine and adjust the electrode.	26
7.6	To remove and clean the photocell.	26
7.7	To check the fuel pump pressure.	27
7.7A	Replacing a fuel pump.	27
7.8	To set the burner combustion.	27
7.9	Removing the baffle systems and cleaning the boiler.	28
7.10	Checking the oil line.	28
7.11	Checking the firevalves.	29
7.12	Checking the flue system.	29
7.13	Checking the provision of ventilation.	29
7.15	Checking the fuel filters and changing where necessary.	29
8	Fault Finding	29
	Introduction to fault finding.	29
8.1	Wiring Diagram.	31
	Illustration showing the control panel cover removed	32
9	Fill in the Warranty Form	32
10	Running Costs	32
10.1	Fuel Consumption.	32
10.2	Electrical Consumption.	32
11	Amendment list	32

1 INTRODUCTION

The Boiler House version of the Bubble P.J. is a purpose designed, heavy-duty, automatic oil fired boiler which will run heating systems up to 17.5 kW. (60,000 BTUs)

It is powered by a down firing pressure jet oil burner used on most of the oil fired heating boilers produced in the UK, because of this it is known by all the oil firing technicians across the United Kingdom.

None of our competitors have this make of burner and all of them use obscure equipment, which can only be serviced by a few specially trained engineers.

Again, unlike our competitors we only use UK standard control systems which are common place across the length and breadth of the UK.

Space above the appliance must be provided for service access to the boiler and vertical removal of the burner, to achieve this the flue system must be so designed as to allow it to slip up from the boiler socket to allow the rear access plate of the boiler to be lifted off.

Simple and basic instrumentation is mounted on a removable front control panel.

Two separate power inputs are required, one is from the time control clock to energise the burner and the other must be provided whilst the burner is timed on.

The second live is required to allow the burner to go through its post purge timing sequence.

The boiler can be used to heat up hot water cylinders, central heating systems, or both.

The water jacket is insulated with foil backed rockwool insulation.

Optional, automatic time control can be provided by a remote programmable time clock.

The operating functions of the boiler are controlled by a running thermostat and a re settable safety stat.

The boiler has been specially developed to fit into confined spaces.

Installation, servicing, faultfinding and operation are both simple and reliable.

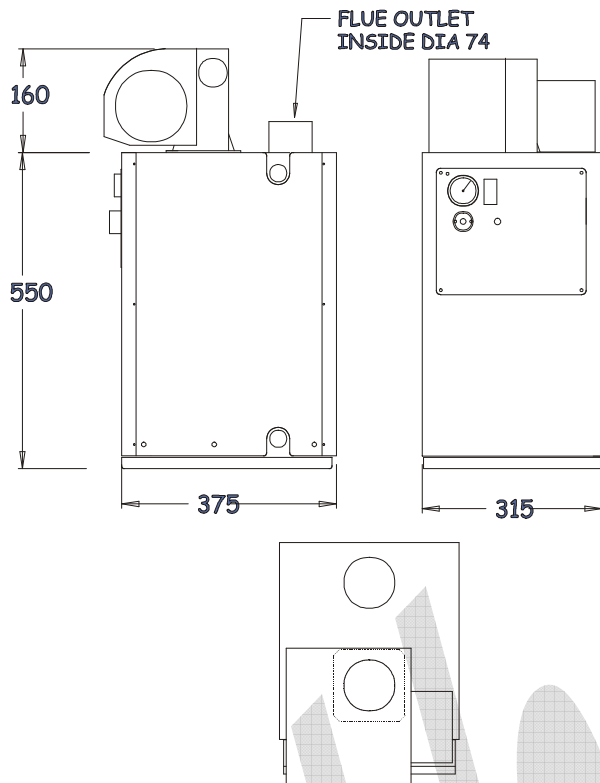

The water content of the boiler is 16 litres.

Fuel tanks and fuel lines should be installed to BS EN ISO 10088:2001

The burner is supplied with a two pipe system, pre piped with appropriate quality hoses.

Fire prevention to BS EN ISO 9094-1:2003

2 OPTIONAL EXTRAS

2.1 REMOTE TIME CLOCK

Can be located in a galley or saloon and the hot water on signal is wired back to the boiler.

2.2 HIGH RECOVERY HOT WATER CYLINDER.

High recovery, unvented hot water cylinders equipped with safety vales and expansion vessels to prevent the wastage of domestic hot water.

The order code for the cylinders are in (section 5) Marine Spares Price List.

2.3 FLUE SYSTEMS.

1. The boiler is fitted with a vertical top flue take off to accept flue pipe of 70mm Dia.

2. Flue systems can be horizontal or vertical depending upon the installation requirements.

3. High temperature flue insulation is available in the form of a wrap around insulation blanket.

2.5 PRESSURISATION KIT FOR NON-POTABLE WATER.

Fig 2.



The Pressurisation kit for non-potable water is supplied as an optional extra.

Installation of this kit is quick, easy and compact.

See section 05 of the Marine Spares Price List.

2.8 PRESSURISATION KIT FOR POTABLE WATER.

The Pressurisation kit for potable water is supplied as an optional extra.

3 MODES OF OPERATION

1. The boiler is energised via a live 230vac input from a manual or automatic source.

2. Once the boiler has received the signal and all the control devices are in a calling mode nothing will happen until the nozzle pre heater is up to temperature.

This can take up to 4 minutes.

3. When the nozzle pre heater thermostat is satisfied the burner will then go through its ignition sequence as follows.

4. Motor runs.

5. H.F. spark is discharged across the electrodes.

6. Seconds later the fuel is released by the solenoid valve.

7. Ignition occurs.

8. Photocell recognizes ignition has occurred.

9. Photocell sends signal to DKO control unit, which turns the H.F. ignition off and then allows the burner to go into run mode.

10. The burner will run until it reaches the pre set temperature at which point it will shut down and then modulate in on-off mode until either the auto or manual supply is removed.

Devices which can control the on off cycle are:-

Cylinder Stat

Room Stat

Boiler stat

Safety Stat

Time clock

When used on diesel fuel, the burner is equipped with a fuel pre heater device, which will take approximately three minutes to heat up after power has been supplied to the boiler.

On kerosene fuel the burner will not need a fuel pre heater device.

Once the boiler has ignited it will modulate in line with demand via the control stat.

The burner is also fitted with a post purge timer, which will allow the burner fan only, to run on for a period of four minutes approx after it has received a shut down signal from the operating stat.

Power Input Connections details are shown in section 4-5.

4 INSTALLATION

ABREVIATED KEY INFORMATION.

EASY ACCESS is the key word when installing boilers.

They must **not** be fitted into situations where access is difficult or awkward.

The burner has to be lifted out of the boiler and the flexi oil feed pipes must not be fitted in such a way as to lock the burner in, there must be enough slack in the flexis to allow the burner to be lifted free of the boiler.

If they are you will find that service engineers will not want to service them or that service costs will be higher because of the extended time involved.

4.1 CLEARANCES FOR SERVICING THE BOILER.

1. The boiler must be fitted in a location, which provides easy access for servicing and controls adjustment.

THIS MEANS

2. The flue must be able to lift out and clear of the flue socket by about 20mm to allow the rear cover plate to be removed for servicing. To achieve this the flue pipe will have to be secured to the deck flange to allow it to self-support when the sliding lower part of the flue is lifted up. (See illustration in section 2-3)_

3. The burner will need to be rotated and lifted at least 80mm to allow for easy removal during servicing or setting up.

4. If the burner is fitted in an enclosed compartment, high and low level ventilation will be required.

The oil supply to the fuel pump on the burner is a two pipe system, make sure that the connection is made as per the direction indicators on the fuel pump and fuel filter.

Fuel will flow via a single feed through the filter and return directly to the fuel supply tank via a separate return, the return can be teed into the engine return if required, there is no need to run the return thro the filter. See 4-7-1

The filter can be fitted in a convenient position near to the appliance, make up interconnecting extension pipes as required, and make sure **that the filter can be easily serviced and exchanged.**

The water content of the boiler is 16 litres

4.2 LOCATION.

EASY ACCESS is the key word when installing boilers.

They must not be fitted into situations where access is difficult or awkward.

If they are you will find that service engineers will not want to service them.

Make sure that the boiler is fitted with adequate space above it.

The burner will need to be lifted at least 80mm to allow for easy removal.

The boiler is serviced from the top and access is required to remove the internal baffle system.

The burner can be fitted with a conventional flue system.

If the burner is fitted in an enclosed compartment, high and low level ventilation will be required.

4-2A CLEARANCES FROM COMBUSTIBLES

The boiler can be fitted up to combustible materials as detailed below but make sure that the burner oil pump is not fitted tightly up to a wall or panel, the commissioning and service engineers will have to gain easy access to adjust the fuel pump pressure and from time to time replace the flexi fuel feed hoses. **60mm minimum gap required from face of fuel pump.**

The objective of fitting flexible oil feed pipes to the burner is to allow the burner to be lifted easily from the boiler without restraint from the flexi oil lines.

Make sure that the burner is not locked into place by tight fitting oil lines.

1. Sides 0mm

2. Base 0mm
3. Back 0mm
4. Front 0mm
5. Top 200mm

UNINSULATED, SINGLE SKIN FLUE PIPE

150 from combustibles.

DOUBLE WALL FLUE PIPE

25mm from combustibles

2. Do not allow soft furnishings such as curtains or loose materials within 200mm of the burner.

3. Loose materials can block the air inlet to the burner.

4. If the boiler is used in the lower part of an airing cupboard make sure that loose materials can't fall on or near to the burner.

4-2B FASTENING DOWN

The boiler must be securely fastened down.

The degree of security depends on the category of use of the vessel to which the boiler is being fitted.

Up to category C, use the standard clips provided.

For category B, optional special fixing brackets can be welded to the drip tray.

4.3 PLUMBING.

Connection to the boiler is made via two $\frac{3}{4}$ " B.S.P.T. male fittings on the right hand side of the boiler.

It is assumed that the boiler will be installed using conventional pipe layouts and controls.

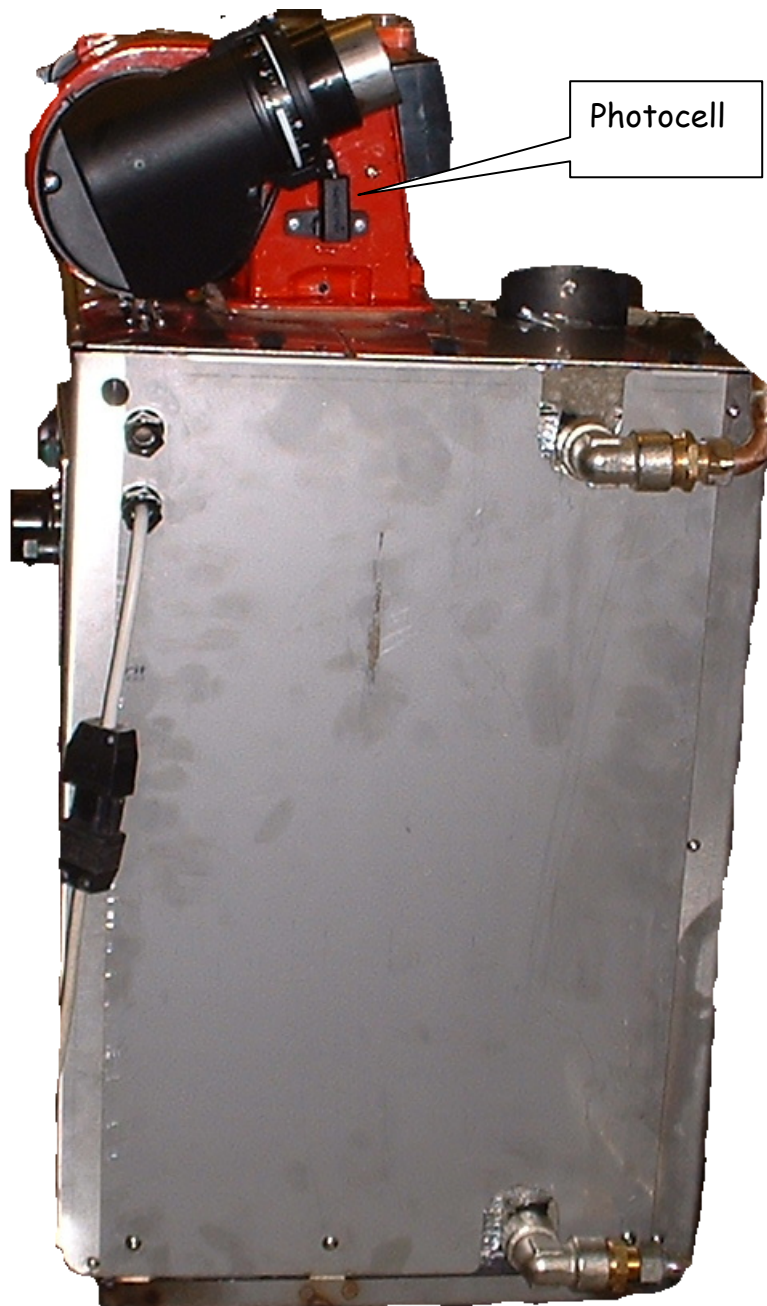

All pipe work (Primary and Secondary) must be free of air traps, where there is a potential for air traps to occur, automatic air vents must be fitted.

4.4 HOT WATER.

The calorifier must be of a suitable design with a high recovery coil fitted.

We can supply calorifiers as required.

4-4A SCHEMATIC GRUNDFOSS TWIN PUMP SYSTEM.

Cottage Twin Burner
 PRESSURIZED HYDRAULIC LAYOUT
 GRUNDFOSS TWIN PUMP VERSION 10-08-04

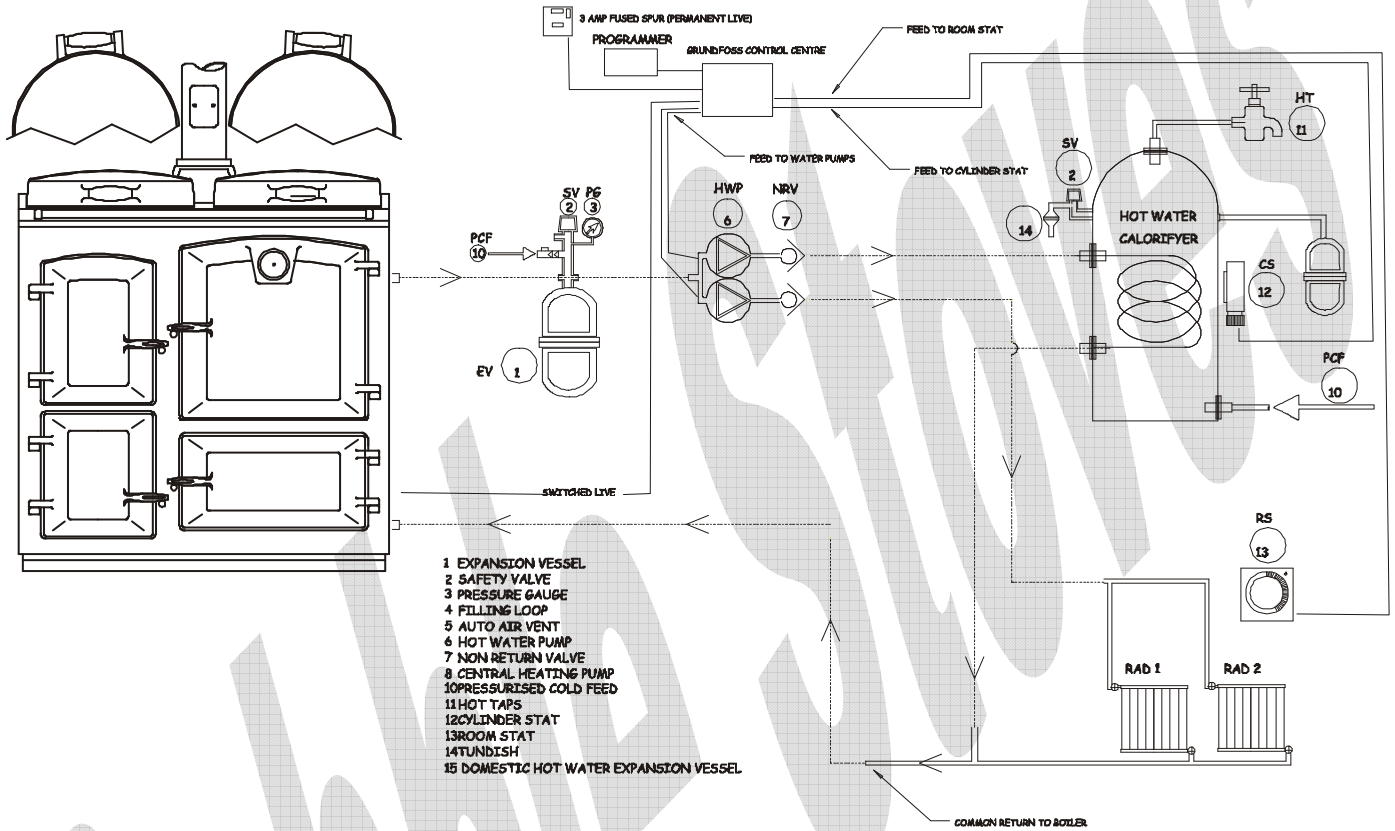

4-4B SCHEMATIC Y PLAN SYSTEM.

230 V PJ
 PRESSURIZED HYDRAULIC LAYOUT
 Y PLAN 23-11-04

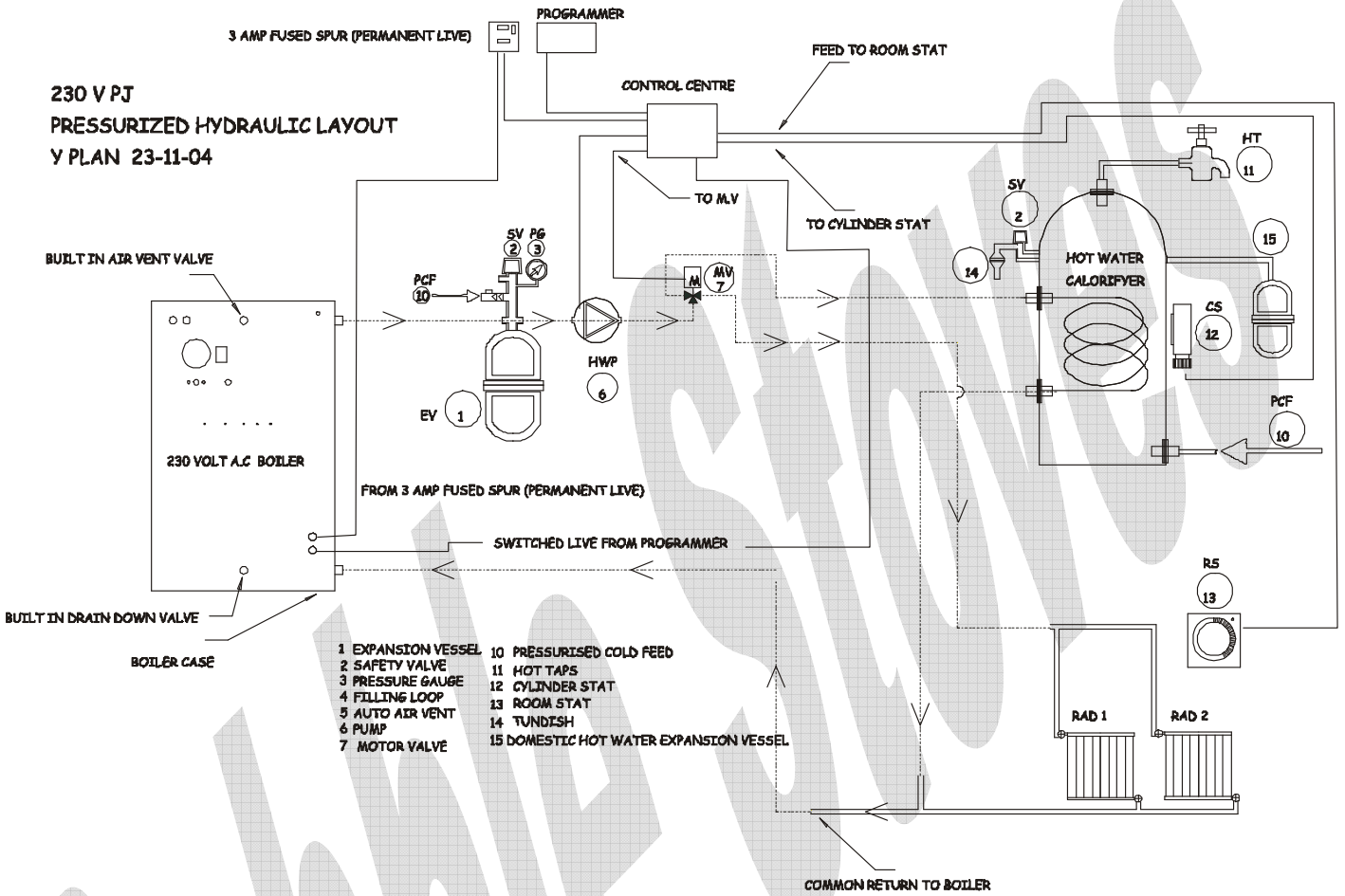

- | | |
|--------------------|--|
| 1 EXPANSION VESSEL | 10 PRESSURISED COLD FEED |
| 2 SAFETY VALVE | 11 HOT TAPS |
| 3 PRESSURE GAUGE | 12 CYLINDER STAT |
| 4 FILLING LOOP | 13 ROOM STAT |
| 5 AUTO AIR VENT | 14 TUNDISH |
| 6 PUMP | 15 DOMESTIC HOT WATER EXPANSION VESSEL |
| 7 MOTOR VALVE | |

4-4c SCHEMATIC S PLAN

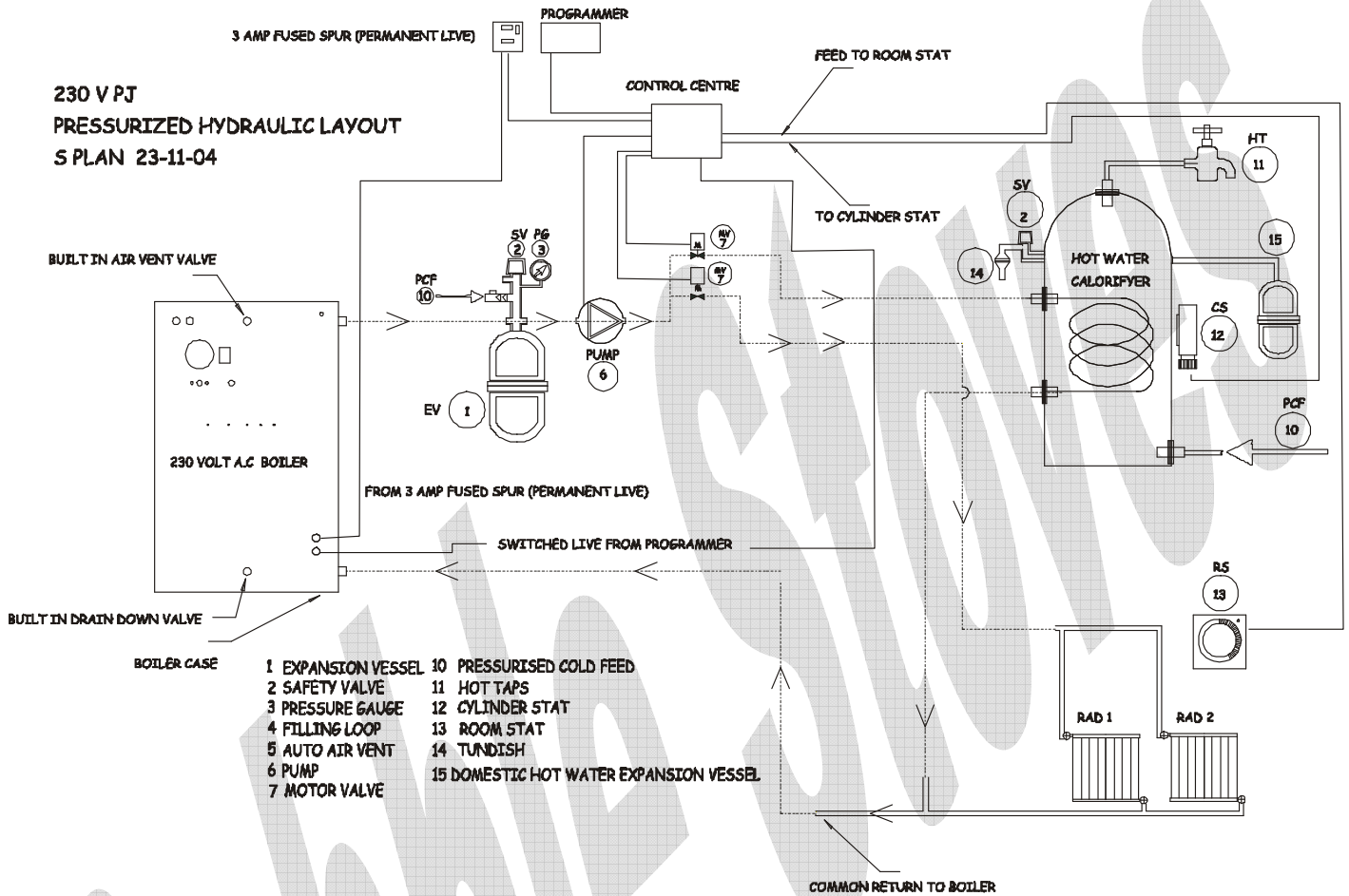

4.5 POWER SUPPLY 230-VOLT A.C.

The boiler can only be connected to a 230 vac mains electrical supply or a full sign wave inverter, any other type of inverter will not be suitable.

If the inverter fails and does not output a full sign wave supply, damage will be caused to the Burner control box located on the burner.

As is described in sec 3, the boiler can be operated in a manual mode or an automatic mode via a time clock or control pack.

The boiler must always have a permanent live wired to it through a fused isolating switch protected by a 6 amp slow blow or 10 amp fast blow fuse.

The burner is supplied with a male and female 7 way connector.

The connections made in the plug are as follows-:

NOTE

1. THE ILLUSTRATION BELOW SHOWS THE BOILER SIDE OF THE PLUG WITH COVER OFF.
2. THE SUPPLY SIDE OF THE PLUG IS NOT SHOWN.

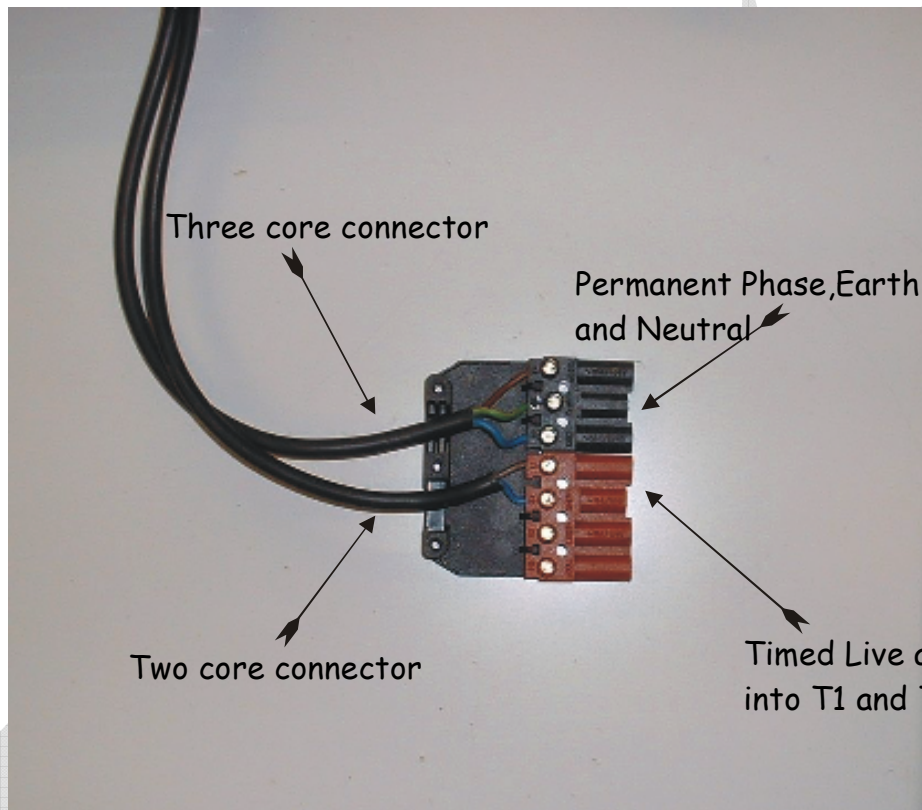

Permanent supply of Phase, Earth and Neutral in the black connections as marked.

Timed supply, Phase into T1 and Neutral into T2.

A permanent live connection is required to allow the boiler to go through its 4 minute post purge cycle on shutdown. (If the permanent live is used to turn the boiler off it will not be able to go through its post purge cycle and as a consequence products of combustion fume may vent back through the air inlet duct on the burner.)

If the boiler is going to be connected to a standard Y, S or Grundfoss pump plan the boiler should be wired according to the wiring diagrams illustrated.

The boiler must be earthed.

4-5-1 TYPICAL CONTROL EITHER Y PLAN, S PLAN OR GRUNDFOSS PUMP PLAN.

Note.

Only qualified electricians are allowed to carry out electrical work on wiring and installing systems.

Most third party systems will have detailed wiring instructions provided with the package of components which will usually comprise of -:

TIME CLOCK PROGRAMMER.

EITHER ONE THREE PORT, (Y Plan) OR TWO SINGLE PORT, (S Plan) MOTOR VALVES.

ROOM STAT.

CYLINDER STAT.

WIRING CENTRE.

Make sure that all wiring into the boiler is correct polarity, inverted supply will damage the burner control.

4.7 OIL SUPPLY.

Fuel tanks and fuel lines should be installed to BS EN ISO 10088:2001

Oil supply to the burner can be via 8 or 10 mm pipe.

Fuel Supply Systems will be piped up as per a single feed through the filter and returned directly to the fuel supply tank from the return hose of the burner fuel pump as per the schematic layout.

Diesel Engine filters with multiple outlets can be used with the return flow going back to the fuel supply tank via the engine return line.

The boiler has a mechanical gear driven pump, which creates its own vacuum to lift oil through the filter.

4.7.1 Schematic Oil Layout

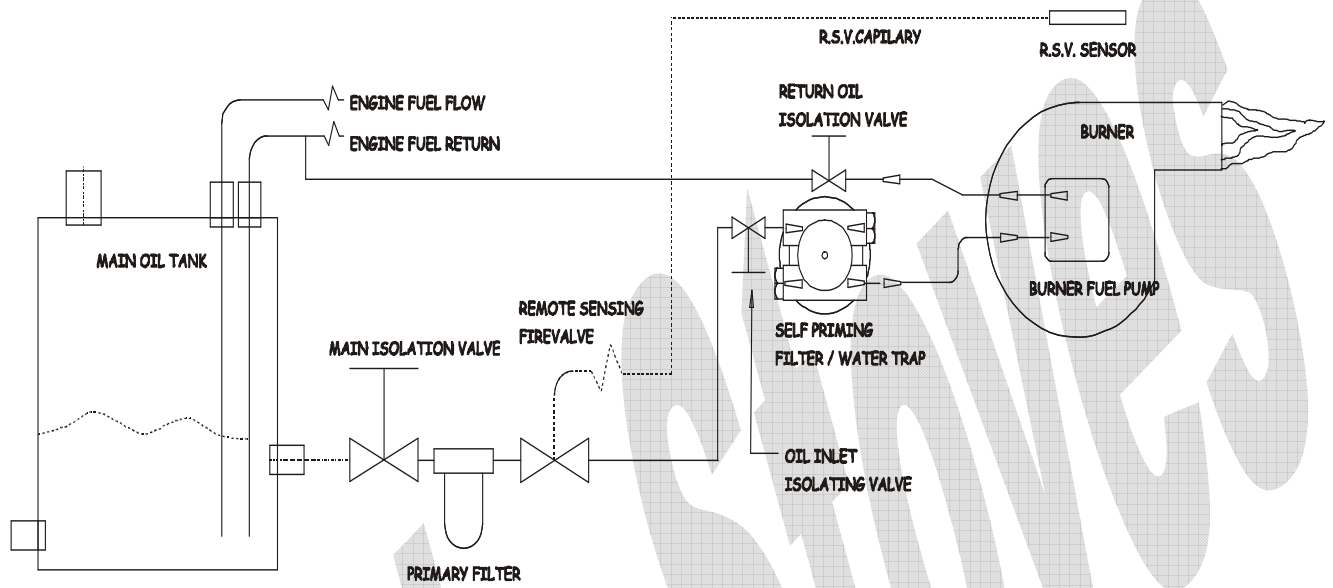

Note

The objective of fitting flexible oil feed pipes to the burner is to allow the burner to be lifted easily from the boiler, without restraint from the flexi oil lines.

Make sure that the burner is not locked into place by tight fitting oil lines.

4.8 FUEL PUMP

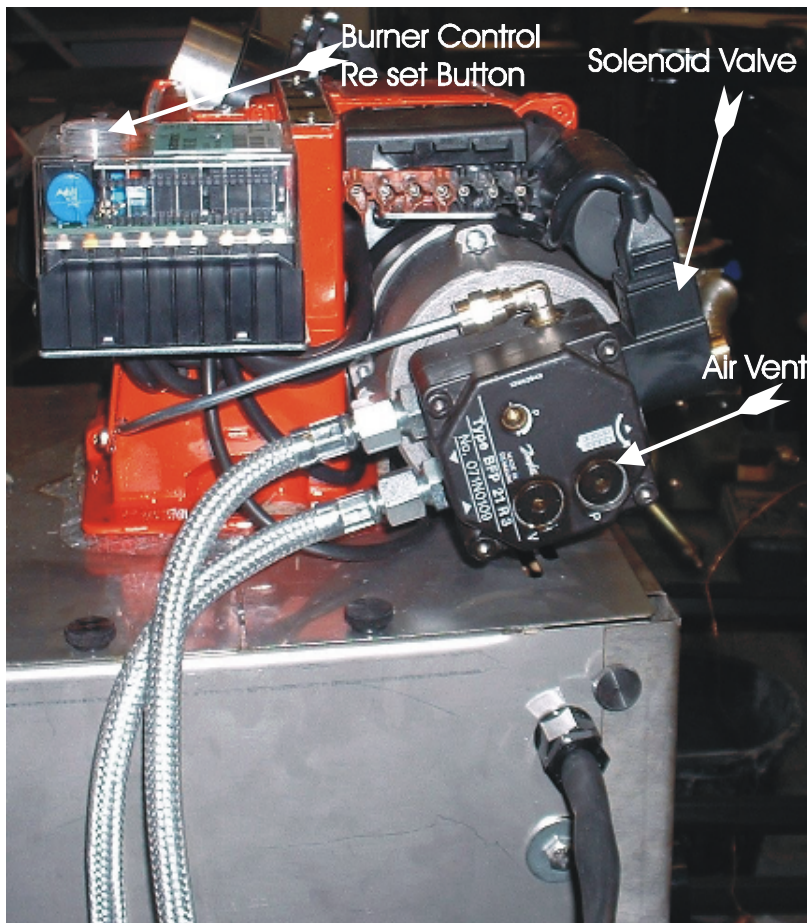

Note

When fitting the boiler make sure that the burner oil pump is not fitted tightly up to a wall or panel, the commissioning and service engineers will have to gain easy access to adjust the fuel pump pressure and from time to time replace the flexi fuel feed hoses.

50mm minimum gap required from face of fuel pump.

4.9 FLUEING.

Fig 1 VERTICAL FLUE OPTIONS

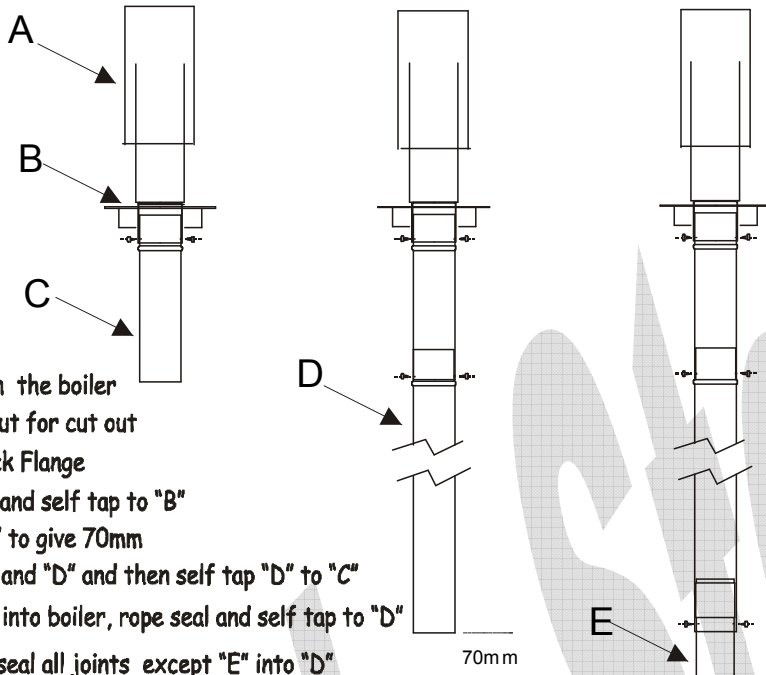

1. Position the boiler
2. Mark out for cut out
3. Fit Deck Flange
4. Fit "C" and self tap to "B"
5. Cut "D" to give 70mm
6. Fit "E" and "D" and then self tap "D" to "C"
7. Fit "E" into boiler, rope seal and self tap to "D"

Silicone seal all joints except "E" into "D"

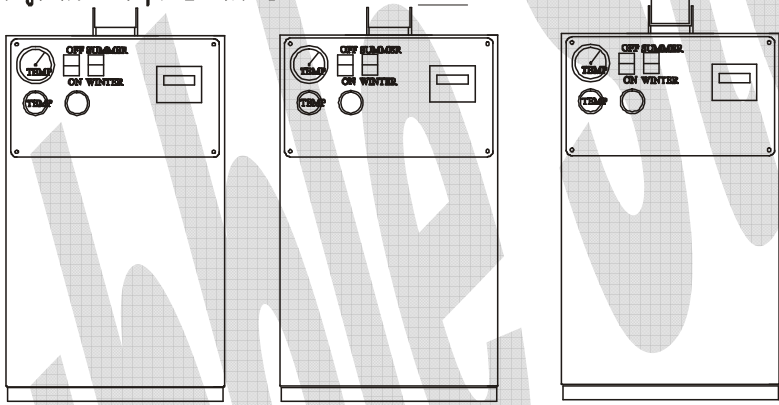
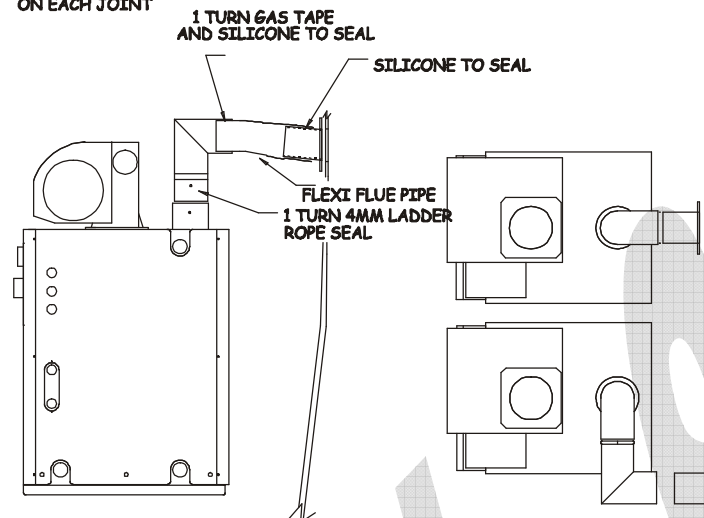

Fig 1A HORIZONTAL FLUE OPTIONS

ALLOW ENOUGH MOVEMENT FOR FLU TO LIFT CLEAR OF SOCKET FOR SERVICING

STAINLESS SELF TAPPING SCREWS
ON EACH JOINT



The boiler is fitted with a vertical top flue take off. See fig 1.

The boiler can be flued horizontally if required via a 90 degree elbow, flexi stainless steel flue pipe and a through side adaptor. (See fig 1a)

The through side adaptor is designed with a 10 degree angle to offset the possibility of water entry.

The orientation of the 10 degree's is market via two small cut outs on the outer diameter of the adaptor.

The adaptor is provided with a series of holes through which it can be welded to the hull side plates.

Adequate provision to stop the ingress of water into the flue system must be made.

In all cases the horizontal or vertical flue pipe must be fitted so as to allow a vertical movement of 100mm min to facilitate boiler servicing.

On vertical flue applications this means that the lower part of the flue must be so designed so as to slide up into the upper part of the flue.

The upper part of the flue will need to be secured to the through deck adaptor so as to make it self-supporting when the lower part is not fitted to the boiler.

To prevent fire hazards, the horizontal or vertical flue pipe must be fully insulated if there is any combustible materials within 150 mm of the outer surface of the flue system.

4.10 VENTILATION.

Adequate ventilation must be provided and this will be calculated at 5cm sq per kW of output.

If the appliance is fitted in a compartment, high and low level ventilation of 10 cm sq per kW of output must be provided for compartment cooling burner combustion purposes.

If the appliance is fitted with a conventional flue system, in a compartment, the flue system must be fully insulated.

6 COMMISSIONING THE BOILER

6.1 READ THIS PREAMBLE BEFORE ATTEMPTING TO FIRE UP.

Before attempting to fire the boiler you will need to make sure that:-

6-1-1. The boiler, the hot water and heating systems are free from air or air locks, *air in the boiler could stop the pump from circulating and cause the burner to rapidly shut down.*

6-1-2. If the boiler is fed with oil via a negative head you will have to use the ignition process to pull oil from the tank and up to the burner, air can be vented from the fuel pump as illustrated in 4-8.

Do not allow any oil to soak into the boiler insulation blanket, which wraps around the boiler.

It may need several ignition attempts to pull oil through.

It is sometimes possible to hear the return oil trickling back into the fuel tank.

If fitted, make sure that the room stat, the cylinder stat, and the boiler stat are all set to call.

NOTE. The boiler is equipped with a fuel pre heater device, which will take approximately three minutes to heat up after power has been supplied to the boiler.

This means that when the all the controls are turned on to fire the boiler up, nothing will happen for at least three minutes.

Once the boiler has ignited it will modulate in line with demand via the control stat without any delay.

However, the burner is fitted with a post purge timer, which will allow the burner fan only to run on for a period of four minutes approx after it has received a shut down signal from the stat.

If the burner does not fire it will lock out after the ignition attempt, to reset it press the flashing button on the burner control box or turn the power on and off for a re-set.

If the boiler stat becomes satisfied it will shut the burner down, but the burner fan will continue running for a 4 minute post purge period.

It is normal for the boiler to pulse on and off; up to it's maximum operating temperature.

6.2 VENT AIR FROM THE BOILER AND HEATING SYSTEM.

Using the temporary filling loop fill the central heating system and vent all air from it.

Watch the pressure gauge and pressurise the heating circuit up to 1.5 bar.

It may be necessary to keep topping up until the system is vented of all air, when it is the pressure gauge should hold at 1.5bar.

6.3 COMMISSION THE HEATING PRESSURE SYSTEM IF FITTED.

Check the action of all pressure release devices

Make sure that the temporary filling loop is disconnected.

6.4 CHECK THE HEATING SYSTEM.

Make sure that all the vents are closed off and balance the system to provide equal flow across all the radiators.

6.5 THE EFFECT OF TRV's.

If you intend to fit TRV's to the heating system you will need to fit a 22mm differential by pass valve.

The by pass valve will be fitted 2 metres from the boiler.

For further advice contact Harworth Heating.

Failure to do this will invalidate the warranty.

6.6 CHECK HOT WATER SYSTEM, EXPANSION VESSEL AND PRESSURE RELEASE DEVICES.

To fill the hot water system open all the hot taps and admit water into the cylinder, check all the joints as the cylinder fills up and vent off all trapped air via all the hot outlets.

When the air has vented off, close the hot outlets and allow the system to come up to pressure.

Check all the pressure release devices and repeat the checks when the cylinder is up to temperature

6.7 CHECKING THE FLUE GAS EMISSIONS AND TEMPERATURE.

Before proceeding with testing the flue gas make sure that: -

You have Dwyer test point plugs and a suitable size of drill.

You have suitable Allen keys.

Your flue gas analyser is in good condition and set for the appropriate fuel.

Drill a suitable hole into the flue approximately 100 mm from the boiler outlet to allow insertion of the flue gas analyser probe.

Fire the burner up and allow the boiler to come up to 60 deg C.

(Whilst the boiler is coming up to temperature keep an eye on the terminal, if there is smoke about increase the air until it goes.)

The burner is fitted with a .4 x 60° S atomising nozzle.

(Always make sure that you have at least three spare nozzles)

The burner fuel pump pressure is set a 9 bar.

The smoke should register zero to one on the bacharach scale.

The net flue gas temperature should be 150 deg C when the boiler water temperature is at 70 deg C. *(If it is slightly lower this is acceptable)*

The efficiency should read off at 86 to 87% in some cases higher.

The CO² should be set to 10.5%.

The O² should be set between 6. To 6.5% this will be approx 3.5 to 4.0 on the air inlet adjustment of the Ecoflam burner.

6.8 COMMISSIONING CHECK TICK LIST.

When power is applied to the boiler, the burner will run for about three seconds and stop, it will then wait for a further three to four minutes to whilst the nozzle pre heater warms up to 60 deg C,

When the pre heater reaches its temperature the boiler will attempt to ignite.

If the boiler does not attempt to ignite make sure that the permanent live is available and the relay has clicked to indicate this.

Make sure that the boiler stat is set to call.

- 1. Check that the boiler is turned on.
- 2. check that the permanent live is applied to the boiler.
- 3. Check that the boiler stat is set to call.

- 4. If the burner attempts to fire but does not fire and goes to lock out, attempt another ignition and whilst the burner is attempting to ignite check that oil is flowing back down the return to tank line.

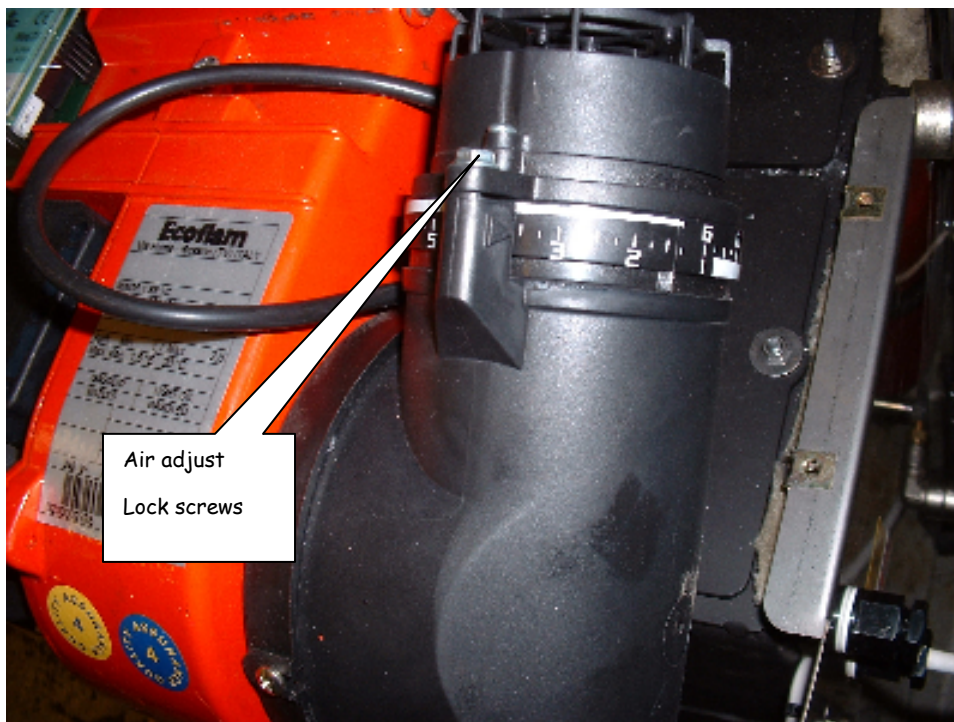

7 ROUTINE MAINTENANCE

7.1 INTRODUCTION.

A conventional 230-volt ac pressure jet burner similar to those used on all land based oil fired boilers powers the burner.

All OFTEC registered land based, oil fired service engineers will be able to service the boiler as per the routine maintenance section.

OFTEC can be contacted on 0845 65 85 080 they have details of all registered service engineers in the UK.

Because the boiler is fired by diesel oil it must be serviced at six monthly intervals.

EASY ACCESS is the key word when installing boilers.

They must not be fitted into situations where access is difficult or awkward.

If they are you will find that service engineers will not want to service them.

Servicing will take the form of -:

7.2 REMOVING AND CLEANING THE BURNER.

When the boiler is fitted a distance of 80 mm clearance above the burner is required to allow space for the burner to be lifted free from the boiler.

Space has to be provided for the service engineer to get his hand over the top of the boiler and down into it for removal of the baffles and vacuum hose access to clean out the base of the boiler.

If boilers are fitted under a worktop in a kitchen or galley environment the worktop over the boiler must be removable to allow the service engineer to gain easy access to it.

The burner fires down into the boiler and is secured by two horizontal grub screws and two fasteners.

One horizontal grub screw locks the burner flame tube into the cast aluminium-mounting flange.

This grub screw can be seen in the side of the aluminium burner mounting flange.

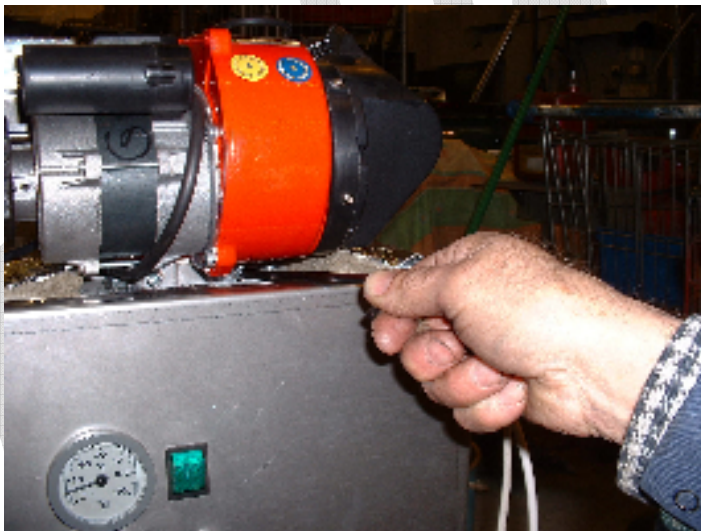

Remove the screw and the burner can then be rotated anticlockwise and lifted out of the boiler. (This will require the use of a long series 6mm allen key.)

When re fitting the burner it is important that the flame must fire concentrically straight down into the centre of the combustion chamber, any deviation could cause excessive sooting to occur on the side faces of the boiler.

Electrical power is supplied to the burner via a large multi pin plug, which has a latched fastener.

Rotate the burner and work it up and off the m8 fasteners.

Note the burner is a tight fit and some rotational movement will be required to get it up and out of the boiler-mounting flange.

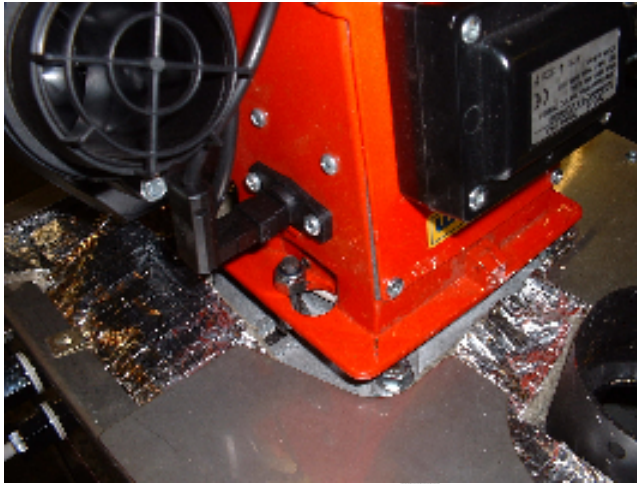

The burner will still be attached to the oil line so take care not to damage, twist or kink the oil line.

Work the burner out from the boiler by simultaneously rotating and lifting it up and out from the top of the boiler.

Once the burner is removed from the boiler it can be stripped down and cleaned as follows.

7.3 TO REMOVE AND CLEAN THE FLAME TUBE.





7.4 TO REMOVE EXAMINE AND ADJUST THE ELECTRODE.



7.6 TO REMOVE AND CLEAN THE PHOTOCELL.

The photocell is plugged into the side of the burner and should be removed for cleaning.

The cell can be located in two positions, when fitting make sure that the cell is not fitted so that it is facing directly at the flame.

7.7 TO CHECK THE FUEL PUMP PRESSURE.

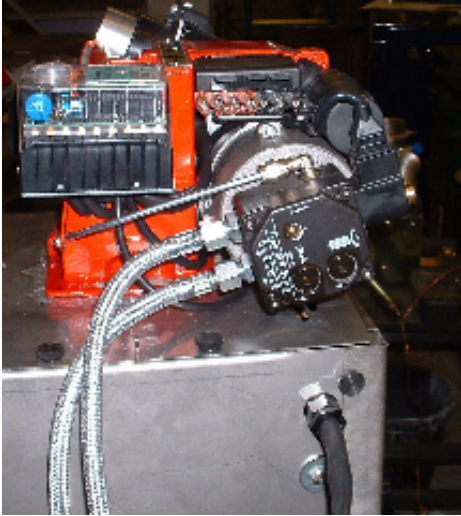

7.7A REPLACING A FUEL PUMP.

If it is found necessary to change the fuel pump make sure that the pump is set up for a two-pipe system.

The fuel pump is a Danfoss BFP 21 R3 No 071N0231

It is held in place via three grub screws located in the rear cast flange of the motor.

7.8 TO SET THE BURNER COMBUSTION.

The burner leaves the factory with the combustion preset to give optimum performance

The settings are as follows:-

Air @t 6.5%

Pump pressure @ 9 Bar

Efficiency @ 87%

Smoke @ 0-1

CO² 10.5%

CO-CO² Ratio .000

Nozzle .4 x 60 deg solid.

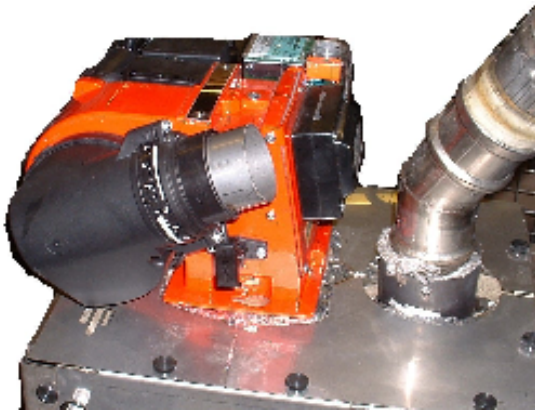

7.9 REMOVING THE BAFFLE SYSTEMS AND CLEANING THE BOILER.

To remove the boiler top plates, the flue system must be so designed as to allow the bottom part of the flue pipe to slip up vertically by a distance of about 80 mm.

Slip the flue pipe up away from the boiler flue spigot by the requisite distance of 80mm.

The boiler has front and rear removable top plates are held in place by 6 x m10 fasteners.

Remove the burner.

Undo the 6 x m10 fasteners remove the front top plate under which is a ceramic top board.

Remove the ceramic top board to gain access to the main baffle

Lift the main baffle out.

Remove the rear boiler top plate.

Once the rear top plate has been removed the boiler baffles can be carefully removed.

To help with the removal of all the baffles there are a pair of aluminium lifting hooks supplied with the boiler)

Note the order of removal and when they are out the boiler and the baffles can be brushed clean and vacuumed out.

Rebuild in reverse order making sure that all the seals are in good condition and airtight.

7.10 CHECKING THE OIL LINE.

Normal flexible oil lines are prone to deteriorate after a two to three years.

Check the oil line for leaks or potential leaks every year and replace it every second year.

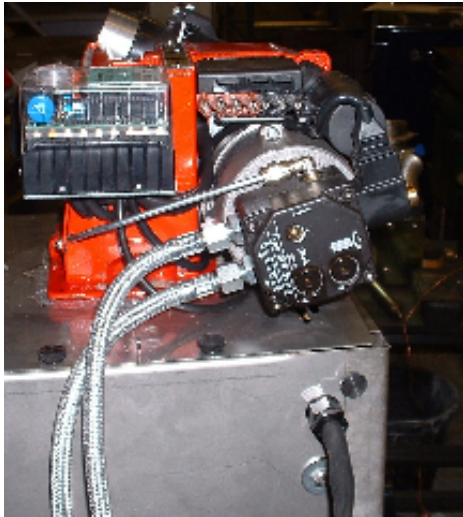

7.11 CHECKING THE FIREVALVES.

The boiler must be fitted with a 60 deg C, remote sensing fire valve, which should be inspected every year.

The sensor of the valve should be located over the boiler at a distance of 200mm above the burner.

7.12 CHECKING THE FLUE SYSTEM.

The flue system need to be checked to make sure that it is airtight.

Use a smoke bomb to carry out this procedure.

7.13 CHECKING THE PROVISION OF VENTILATION.

Make sure that the boiler has adequate ventilation for cooling and combustion purposes.

Make sure that all purpose made vents are free from obstruction.

7.15 CHECKING THE FUEL FILTERS AND CHANGING WHERE NECESSARY.

8 FAULT FINDING

INTRODUCTION TO FAULT FINDING.

Fault finding is divided into the following categories.

8-1. BURNER FAULTS.

Introduction to Burner faults.

Because the burner runs on diesel fuel and is also down firing, there are a few differences, which the service engineer needs to know.

The burner uses a Nozzle pre heater.

From a cold start, the pre heater will take approx two minutes to heat up and allow the burner to go through an ignition attempt.

The controller also has a built in post purge timer which is designed to allow the burner fan to post purge the products of combustion for a period of 4 minutes.

To allow the burner to go through its post purge cycle a permanent live is wired into a relay, wired in series with the control stat.

After a stat satisfied signal, the post purge timer will allow the fan to run for four minutes, if during this post purge period it receives a demand signal from the boiler stat, the burner will ignite.

1. Smoke is emitted from the flue terminal.

Change the nozzle.

Check for an obstruction on the burner air inlet

Check that the burner fan motor is running at optimum revolutions.

Check that the internal boiler baffle system is not distorted, damaged or sooty.

Remove the boiler internal baffle system and check that the boiler is not contaminated with excess soot, if it is, brush and scrape both of the boiler flue ways and vac the soot out from the bottom of the boiler making sure that there is no obstruction in the base of the boiler.

8-2. INTERNAL BOILER CONTROL SYSTEM FAULTS.

1. Burner runs on continuously in post purge mode.

A1. Pre heater thermostat is not making or post purge timer is not timing out.

8-3. EXTERNAL TIME CLOCK PROGRAMMER FAULTS

8-4. EXTERNAL CONTROLS FAULTS

8-5. FUEL SUPPLY PROBLEMS.

8-6. FLUE AND EXHAUST FAULTS

8-7. BURNER SERVICING

8-8. BOILER SERVICING

8-9. ABOUT THE BOILER AND ITS CONTROL REQUIREMENTS.

Because the burner runs on diesel fuel and is also down firing, there are a few differences, which the service engineer needs to know.

The burner uses a Nozzle pre heater.

The controller is designed to allow the burner to post purge the products of combustion for a period of 4 minutes.

To allow the burner to go through its post purge cycle a permanent live is wired into a relay wired in series with the control stat.

This simple arrangement allows the boiler to be used in conjunction with standard off the shelf Y or S plan control systems, schematic layouts are illustrated.

If the burner fails to ignite a warning light on the control top will illuminate, after a period of two minutes, this can be pressed to clear the warning light and a further ignition attempt will be made.

If the burner does not ignite and goes to lock out again call a service engineer.

Do not keep attempting to ignite the boiler.

8.1 WIRING DIAGRAM.

Ref mod 14-07-05

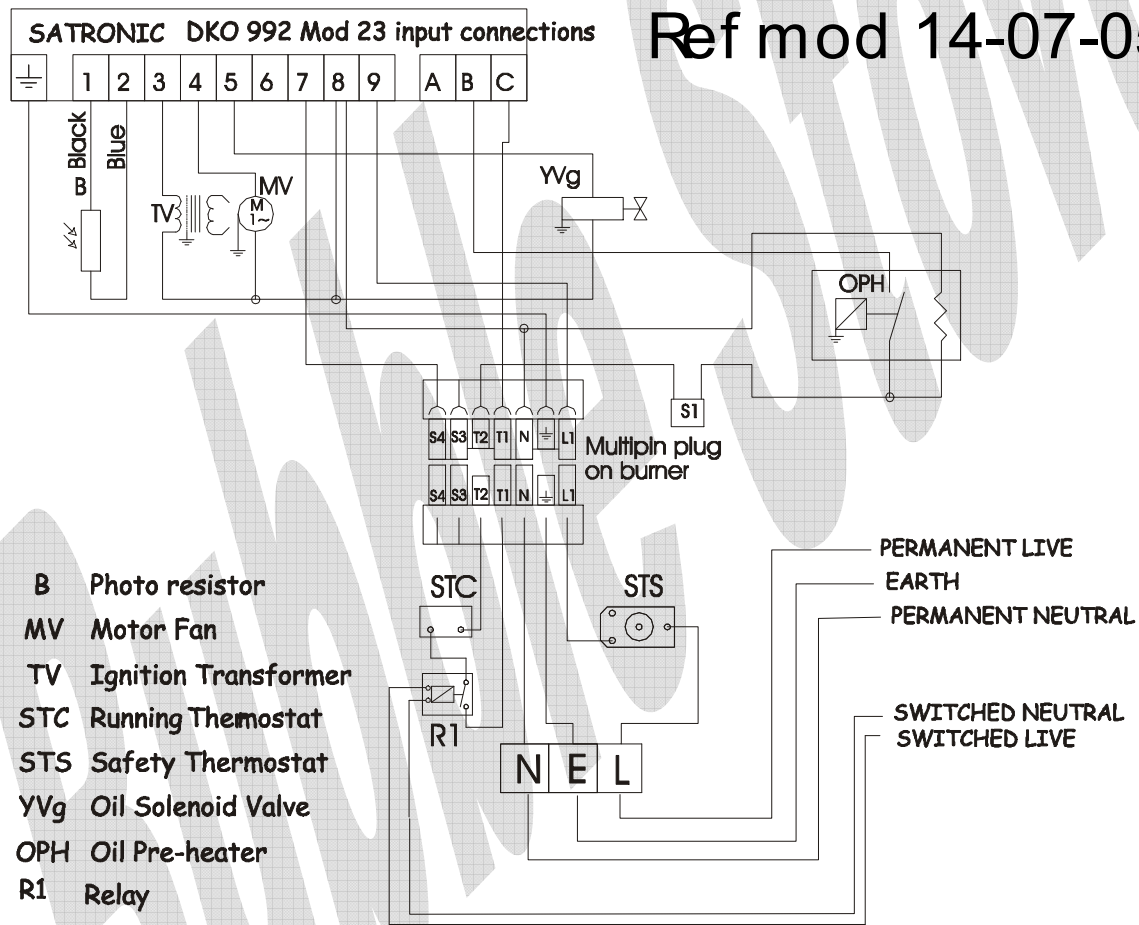
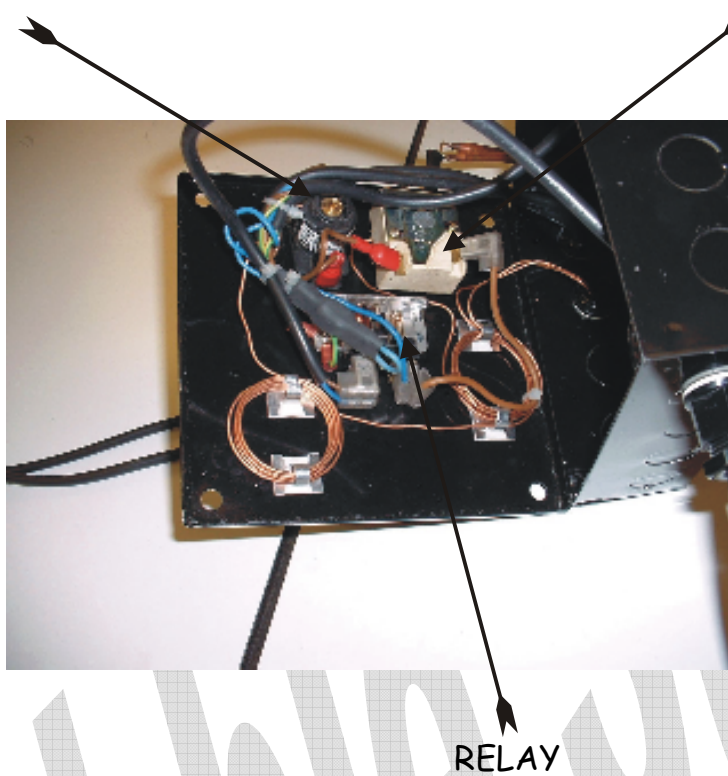

Illustration showing the control panel cover removed

SAFETY STAT

RUNNING STAT



Copyright Harworth Heating 2003

9 FILL IN THE WARRANTY FORM

Fill in the warranty form and return it back to the manufacturers for future spares reference purposes.

10 RUNNING COSTS

10.1 FUEL CONSUMPTION.

The burner is fitted with a .4 U.S.Gallon Nozzle set up at 9 bar fuel pump pressure.

For normal timed use the boiler should use about 42 litres per 7-day week.

10.2 ELECTRICAL CONSUMPTION.

The burner automatically stops and starts therefore it only consumes electrical energy when a demand is placed on the control system from either the room or cylinder stats.

11 AMENDMENT LIST

20-07-03-1 Horizontal flue drg added, 2 Picture of air adjustment added.

14-02-04 -1 Relay added and wiring diagram altered -2 Text regarding relay addition added. (About the boiler and it's control requirement.) 3- Fault Finding (Introduction to Fault Finding)

26-02-04-1. Fuel consumption figure added.

11-08-04-1. Y, SAND GRUNDFOSS Wiring diagrams added

27-05-05 Info added.

1. Leave slack in flexi oil lines to allow burner removal.
2. Leave adequate clearance for a service engineer to get to the left hand side of the burner for adjustment of the pump pressure.
3. Leave enough space at the left hand side of the burner to allow the burner to rotate for removal.
4. Do not allow clothing to obstruct air vents or burner air intake.
5. Do not invert mains electrical supply.