

## **WARNING**

**This information is a copy of an original archive, therefore Aga cannot be held responsible for its continued accuracy.**

# THE LITTLE WENLOCK GAS (GS1i)

## Users Instructions

### Consumer Protection Act 1987

As manufacturers and suppliers of cooking and heating products, in compliance with Section 10 of the Consumer Protection Act 1987, we take every care to ensure, as far as is reasonably practicable, that these products are so designed and constructed as to meet the general safety requirement when properly used and installed. To this end, our products are thoroughly tested and examined before despatch.

**IMPORTANT NOTICE:** Any alteration that is not approved by Aga-Rayburn, could invalidate the approval of the appliance, operation of the warranty and could also affect your statutory rights.

### Control of Substances - Health and Safety Important

This appliance may contain some of the materials that are indicated

below. It is the Users/Installers responsibility to ensure that the necessary personal protective clothing is worn when handling, where applicable, the pertinent parts that contain any of the listed materials that could be interpreted as being injurious to health and safety, see below for information.

**Firebricks, Fuel beds, Artificial Fuels** - when handling use disposable gloves.

**Fire Cement** - when handling use disposable gloves.

**Glues and Sealants** - exercise caution - if these are still in liquid form use face mask and disposable gloves.

**Glass Yarn, Mineral Wool, Insulation Pads, Ceramic Fibre, Kerosene Oil** - may be harmful if inhaled. May be irritating to skin, eyes, nose and throat. When handling avoid inhaling and contact with skin or eyes. Use disposable gloves, face-masks and eye protection. After handling wash hands and other exposed parts. When disposing of the product, reduce dust with water spray, ensure that parts are securely wrapped.

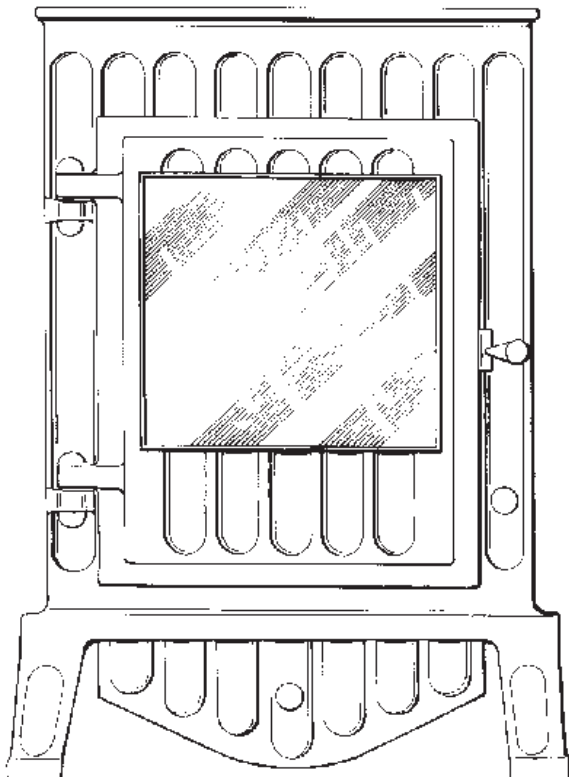

DESN 510141 'A'

**STANDARD DOOR  
OPTION**

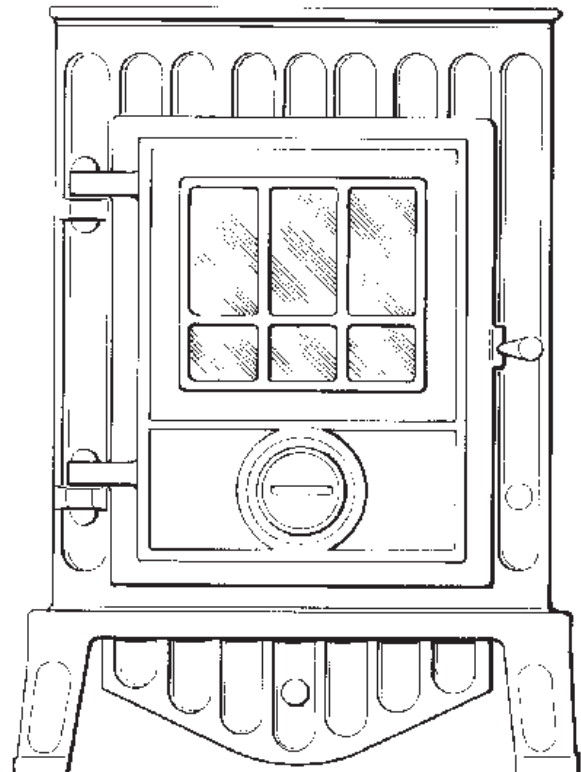

DESN 510274 'B'

**TRADITIONAL DOOR  
OPTION**

Dear Customer,

Your gas stove is for use on either **natural gas or propane**. It **must be** installed by a competent person (e.g. A CORGI Registered Installer) in accordance with the Installation Instructions and operated in accordance with these users instructions if so it should provide many years of safe and efficient operation.

Please complete the separate guarantee card and return it to us within 28 days of purchase. This will enable us to record the details of your purchase and keep you advised of any future developments.

We thank you for purchasing our product and trust it will provide many years of excellent service.

## GUARANTEE

The components of this appliance are guaranteed for one year. We agree to repair free of charge or, at our option, replace the appliance or part thereof which may prove to be defective within one year of purchase.

Please retain your purchase receipt. Our Service Engineer will need to see this in the event of a claim under warranty.

## IMPORTANT NOTES

Your Little Wenlock Gas (GS1i) is a natural gas or propane gas stove.

Due to the newness, the stove may give off a slight smell for a short period after commissioning. This is quite normal and will disappear after a few hours of operation, open doors and windows if required.

The installation of the stove must be carried out by a competent person (e.g. CORGI Registered Installer), in accordance with the installation instructions and the current Gas Safety (Installation and Use) Regulations 1984 (as amended). Failure to install the appliance correctly could lead to prosecution.

Before installation of your stove your installer should check that the chimney is sound, free from obstruction and clean. If a brick chimney is to be used for the gas stove it **MUST** be swept prior to the installation.

The hearth under the stove should never be covered with combustible flooring or material. Do not obstruct the space beneath the stove.

**WARNING: DO NOT OPERATE THE STOVE WITH THE GLASS DOOR OPEN OR IF THE GLASS IS CRACKED OR BROKEN. THE DOOR MUST ALWAYS BE CLOSED USING THE TOOL PROVIDED.**

The Little Wenlock Gas (GS1i) has been designed similar to a solid fuel stove to relevant safety standards, but during use all external working surfaces of the appliance can become **HOT** to touch. We recommend that you provide and secure a fireguard complying with BS. 6539

when the room is used by elderly, infirm or young persons.

Any alteration after the initial installation must be in accordance with the requirements of the Installation and Servicing Instructions. Clarification of combustible material clearances, hearth dimensions, shelf heights and flue requirements are detailed in the sections 'Location and The Flue'.

The chimney should be checked on a regular basis to ensure continued clearance of combustion products and that there is no accumulation of debris or soot etc. It is recommended that the appliance is inspected/serviced annually by a competent person (e.g. A CORGI Registered Installer).

Combustible furniture or material **MUST NOT** be placed closer than 1m in front of the stove.

It is **NOT** recommended to have any materials, such as curtains, above the appliance or to within 1m at the sides.

Clothing or other flammable material should **NOT** be placed on the stove.

Blown vinyl wallpaper or similar materials which have a raised pattern, are easily affected by heat and may scorch or become discoloured close to a heating appliance.

The door tool must be stored in a safe place out of the reach of children.

The appliance should under **NO** circumstances be utilised for solid fuel.

## OPERATION OF THE STOVE

The gas to the stove is controlled by a pilot light, control knob and a safety feature called a flame supervision device.

To gain access to the gas control knob, remove the control cover (fig. 1).

The tap-knob bezel is marked with positions for OFF (●), PILOT (✂) and a graduated section for minimum and maximum, gas rate (fig. 2).

The stove is fitted with a piezo spark ignitor.

**NOTE: If the main burner or pilot are extinguished for any reason, DO NOT attempt to relight the pilot for three minutes.**

## TO LIGHT THE PILOT

Remove the control knob cover. Ensure that the glass door is closed and locked and that the control knob is in the OFF (●) position (Fig. 2).

Fully depress the control knob and turn anti-clockwise (keeping the control knob fully depressed until the spark position (✂) is reached (Fig. 2). If the pilot has not lit repeat the operation.

Once the pilot is lit continue to hold in the control knob for a further 10 - 15 seconds to establish the pilot. When the control knob is released the pilot should remain alight. If the pilot fails to remain alight refer to fault finding section of this document.

If required the pilot may be lit by a long spill or taper as follows:

Open the door of the stove (using the tool supplied) (See Fig. 3).

Apply a lighted spill or taper to the pilot (See Fig. 4) positioned at the front LH side of the burner tray.

Fully depress the control knob and turn anti-clockwise (keeping the control knob fully depressed) until the spark position (✂) has been reached and the pilot should light.

Once the pilot is lit remove the long spill or taper, continue to hold the control knob for 10 - 15 seconds to establish the pilot. When the knob is released, the pilot should remain alight. If the pilot fails to remain alight, repeat the procedure, but hold the knob in longer.

**When pilot is established close the door (using the tool supplied.)**

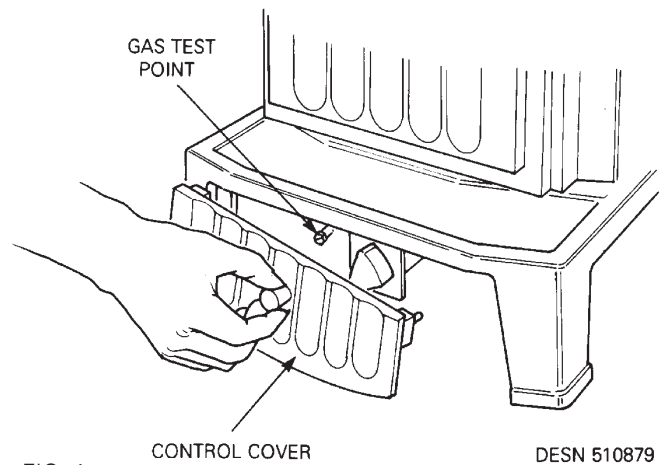

FIG. 1

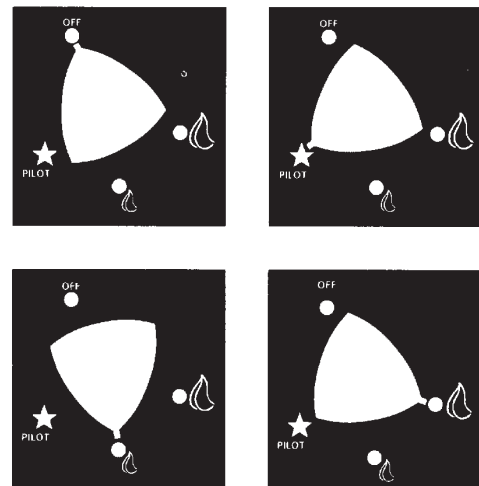

FIG. 2

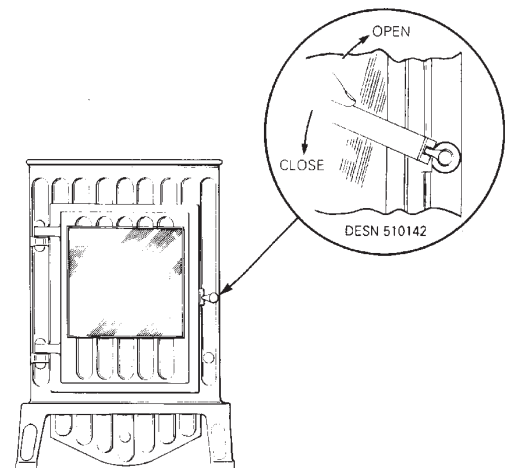

FIG. 3

DESN 510141 'A'

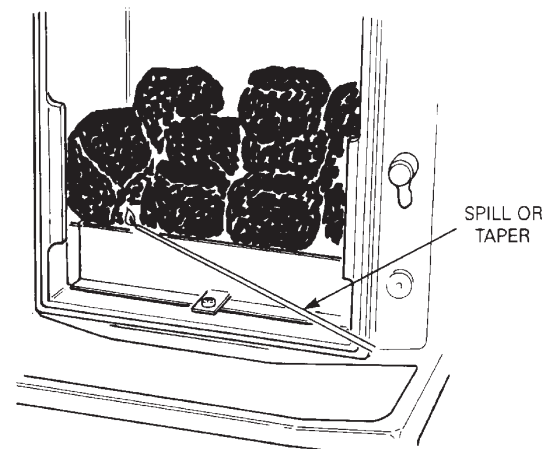

FIG. 4

DESN 510880

## TO LIGHT THE STOVE

If the pilot is not already alight, light the pilot as described. Slightly depress and turn the control knob anti-clockwise from the pilot position (🔥) (See Fig. 5). The fire will ignite.

Adjust the heat output as required by turning the control knob clockwise towards the minimum position (🔥) (See Fig. 6)

To ensure correct operation of the stove it is recommended that it is **NOT** operated below the minimum setting.

Replace the control cover.

## TO TURN THE STOVE OFF

Turn the gas control knob to the minimum gas rate position (🔥) (Fig. 7), slightly depress the knob and continue turning to the pilot position (🔥) (Fig. 8). The fire will go out and the pilot will remain lit and may be left on permanently.

## TO TURN THE STOVE AND PILOT OFF

Turn the stove off as described. Depress the control knob, turn to the off position (●) (Fig. 9) and the pilot will go out.

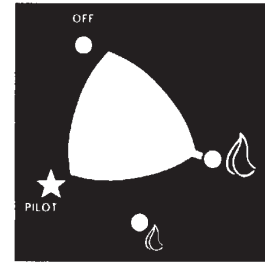

FIG. 5

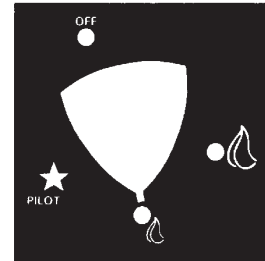

FIG. 6

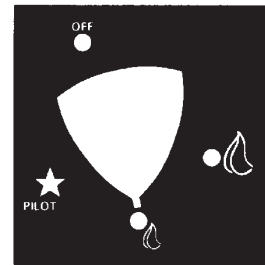

FIG. 7

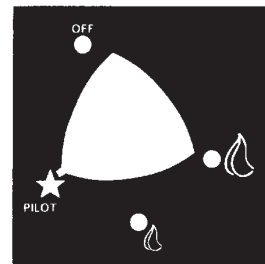

FIG. 8

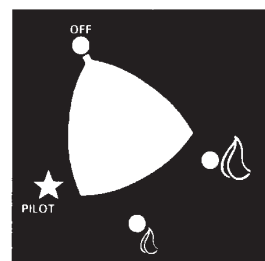

FIG. 9

## CLEANING

Cleaning should be carried out when the stove is turned **OFF** and is cold.

The exterior of the stove can be cleaned with a vacuum cleaner or dusted with a soft brush, either dry or moistened by drawing the bristle over a damp cloth.

A cloth is not recommended as it can leave fibres behind.

The flame effect of the stove may deposit some soot in the coals, or back of the stove. This is quite normal and need not be cleaned off but if desired can be removed by careful use of a soft brush.

**WARNING: DO NOT A VACUUM CLEANER**

Remove the coals for cleaning and replace as described opposite.

## REMOVING AND REPLACING COALS

**Ensure that the stove and pilot are turned OFF and that the stove is cold.**

Open the door of the stove. (Using the tool supplied Fig. 3)

In time due to expansion and contraction the 'coals' may settle. The settlement of the 'coals' may cause minor abrasions and expose some white spots. These white spots usually add realism to the stove when in operation.

**UNDER NO CIRCUMSTANCES TRY TO RE-COLOUR THE COALS WITH PAINT.**

If the settlement of the 'coals' has produced any unsatisfactory flame pattern, or if the 'coals' need to be replaced, remove the existing 'coals' and replace as follows:

**Ensure that the coal guard is correctly located as illustrated in Fig. 10.**

### Positioning the Coals

Carefully place the coals on the coal bed as illustrated in Figs. 11, 12 , 13, 14 and 15.

Close the door and lock (using the tool supplied).

**WARNING: USE ONLY THE SIMULATED COALS SUPPLIED WITH THE APPLIANCE TO BUILD THE BED. UNDER NO CIRCUMSTANCES USE EXTRA COALS OR PUT ANY OTHER MATERIALS ON THE FUEL BED.**

**DO NOT OPERATE THE STOVE WITH THE DOOR OPEN OR IF THE GLASS IS CRACKED OR BROKEN.**

Hands should be washed after handling coals. (if gloves are not used).

# LAYING THE FUEL BED

POUR THE CLAY AGGREGATE SUPPLIED INTO THE TRAY UNTIL IT IS FLUSH WITH THE TOP OF THE BURNER TRAY.

FIT THE COAL GUARD TO THE FRONT OF THE BURNER TRAY, ENSURING THAT IT IS CENTRALLY LOCATED.

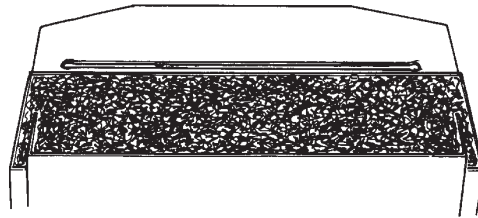
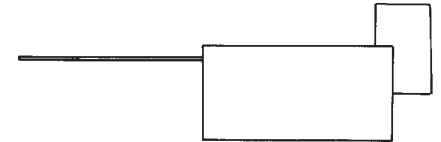

FIG. 10



DESN 510881

PLACE 4 LARGE COALS TO THE REAR OF THE BURNER TRAY AS SHOWN.

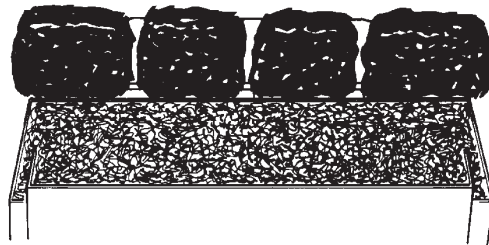
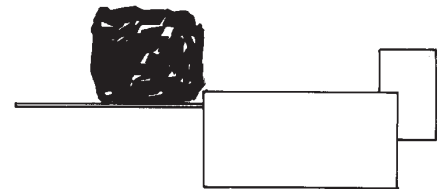

FIG. 11



DESN 510882

PLACE 3 LARGE COALS ON TOP OF THE 4 COALS AS SHOWN.

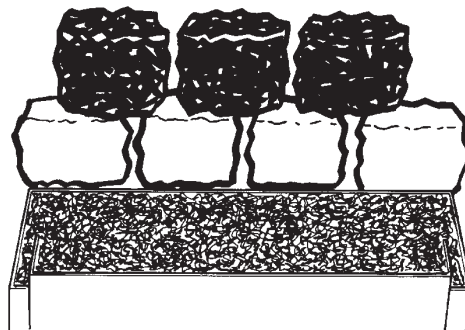
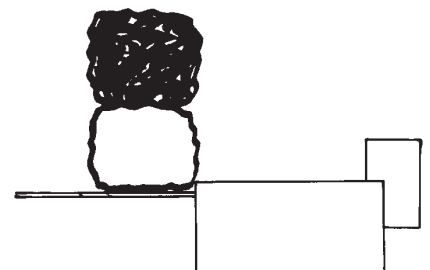
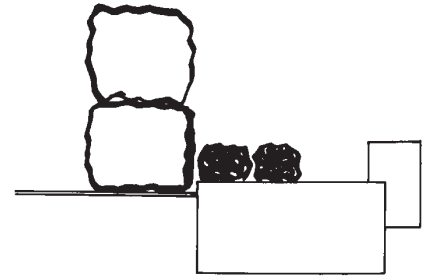
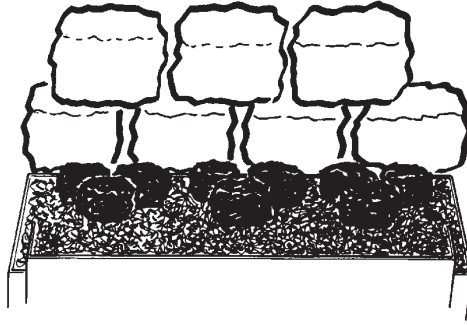

FIG. 12



DESN 510883

PLACE THE 9 SMALL COALS  
ONTO THE AGGREGATE IN  
GROUPS OF 3 AS SHOWN.



DESN 510884

FIG. 13

PLACE 3 LARGE COALS ON TOP  
OF THE SMALL COALS AS SHOWN.

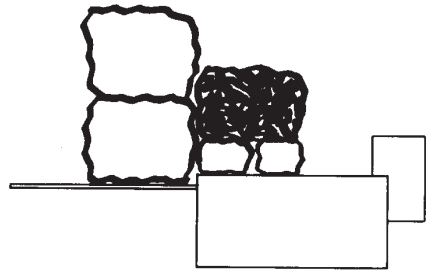
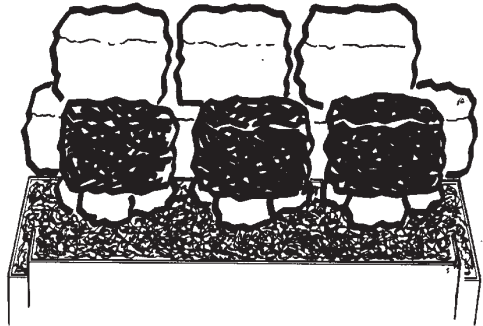

DESN 510885

FIG. 14

PLACE THE REMAINING 4 LARGE  
COALS ACROSS THE FRONT OF  
THE BURNER TRAY/COAL GUARD  
AS SHOWN.

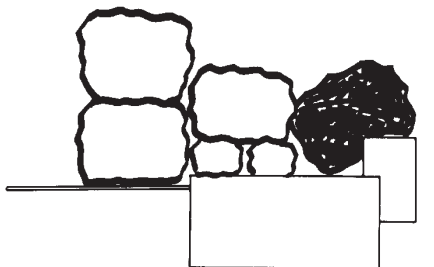

DESN 510886

FIG. 15



## MAINTENANCE

If you require any of the below user replacement items or if you have any difficulty with the fire, consult your original supplier quoting the stove's name. Coalbrookdale GS1i - Serial number (found on Data Plate on inside of glass door).

Serial No:

The appliance should be serviced annually by a competent person (e.g. CORGI Registered Installer).

## HEAT OUTPUT (GROSS)

### Top Rear Open Flue Model

| Maximum Setting | Minimum Setting |
|-----------------|-----------------|
| NG              | NG              |
| Output          | Output          |
| 3.95 kW         | 1.75 kW         |
| Maximum Setting | Minimum Setting |
| PROPANE         | PROPANE         |
| Output          | Output          |
| 3.50 kW         | 1.60 kW         |

### Closure Plate Model

| Maximum Setting | Minimum Setting |
|-----------------|-----------------|
| NG              | NG              |
| Output          | Output          |
| 3.95 kW         | 1.87 kW         |
| Maximum Setting | Minimum Setting |
| PROPANE         | PROPANE         |
| Output          | Output          |
| 3.41 kW         | 1.87 kW         |

## REPLACEMENT ITEMS

These are available from your supplier, and such items which can be changed are:

| ITEM           | MAKERS PART NUMBER |
|----------------|--------------------|
| Control Knob   | HG4M999413         |
| Coals Pack     | HG4M410133         |
| Aggregate Pack | TCLY410132         |
| Door Tool      | HS1M93003          |

With Aga-Rayburn's policy of continuous product improvement, the Company reserves the right to change specifications and make modifications to the appliance described and illustrated at any time.



Manufactured by  
Aga-Rayburn  
Station Road, Ketley, Telford, Shropshire, TF1 5AQ  
Telephone (01952) 642000 Fax (01952) 641961

**For further advice or information contact your local distributor/stockist**

[www.aga-rayburn.co.uk](http://www.aga-rayburn.co.uk)  
[www.agacookshop.co.uk](http://www.agacookshop.co.uk)  
[www.agalinks.com](http://www.agalinks.com)  
[www.cookcraft.com](http://www.cookcraft.com)