

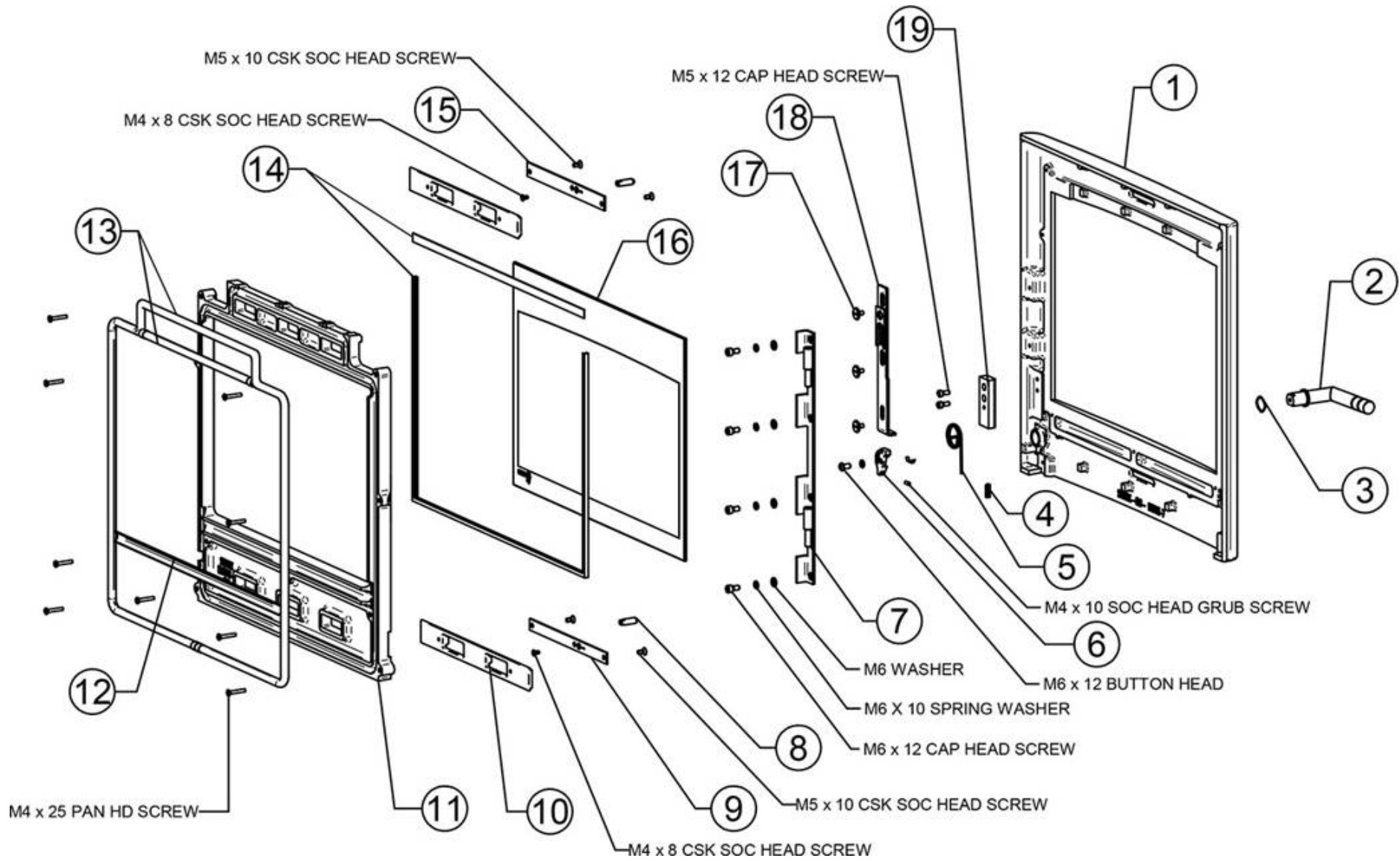











Yeoman CL8 Door Exploded Diagram



Yeoman CL8 Door Exploded Diagram

Ref.	Product Code		Description
1	CA7613		View 8 Outer Door Frame
2	ME600422		View Door Spring
3	MEC9553		View Hinge Assembly
4	CE7703		View 8 Door Glass
5	4950		15mm x 2mm Self Adhesive Rope Seal -2m Pack
6	ME600525		View 8 Mk1 Primary Air Slider Cover Plate
7	CA7642		View 8 Primary Air Slider
8	CA7636		View 8 Glass Clamp Frame
9	4952		15x2mm Mid Door Rope Seal (2M Handy Pack) 450mm length required.
10	5704		13mm Black Rope Seal with Adhesive - 3.5m Pack 410mm+2300mm length required.

Yeoman CL8 Door Exploded Diagram

Ref.	Product Code		Description
11	4950		15mm x 2mm Self Adhesive Rope Seal -2m Pack 450mm+1220mm length required.
12	CA7637		View 8 Air Control Slider
13	ME600443		View 8 Mk1 Air Control Cover Plate
14	FA9510		Shoulder Screw - Single Screw
15	ME600563		View Large Shoulder Screw
16	MEC8641		View Mk1 Door Catch Slider