



Geoman
A NATURAL WARMTH

Wood and Multi-fuel Stoves



A Natural Warmth

From its humble Dartmoor origins, dating back to over 30 years ago, Yeoman has grown to become one of the UK's leading stove manufacturers. Today, we offer a wide selection of both traditionally-styled stoves and contemporary styled stoves, in woodburning, multi-fuel, gas and electric versions. Our range even includes solid fuel high-output boiler stoves for a complete and natural home heating solution. Whichever model you choose, each stove is designed to provide years of enjoyment whilst offering superb value for money.

The Yeoman Range

Traditional Wood & Multi-Fuel Stoves..... 8 - 15

A comprehensive collection of classically designed stoves, incorporating the unmistakable atmosphere of a real log or smokeless fuelled fire. From the compact Exmoor model to the grander County, that true rural ambiance can be perfectly attained in rooms of all sizes.



CL Wood & Multi-Fuel Stoves..... 16 - 31

For those with a more contemporary taste, the eye-catching CL range with clean geometric designs, brings woodburning and multi-fuel stoves right into the heart of 21st century living.



Traditional & CL High-Output Boiler Stoves 32 - 37

Complete home heating never looked so good. These four exceptionally efficient stoves not only heat the room they are in, but can also provide enough hot water to supply up to 19 radiators throughout the rest of the house. Choose from classic or contemporary styles.



Double-Sided Stoves 38 - 39

Truly the ultimate centre-piece, these exquisite stoves bring two rooms together with your choice of three timeless designs.



Gas and Electric Stoves and Fires

Yeoman's range of gas and electric stoves and fire are available in a separate brochure or can be viewed online at www.yeomanstoves.co.uk, please see pages 46-47 for more information.

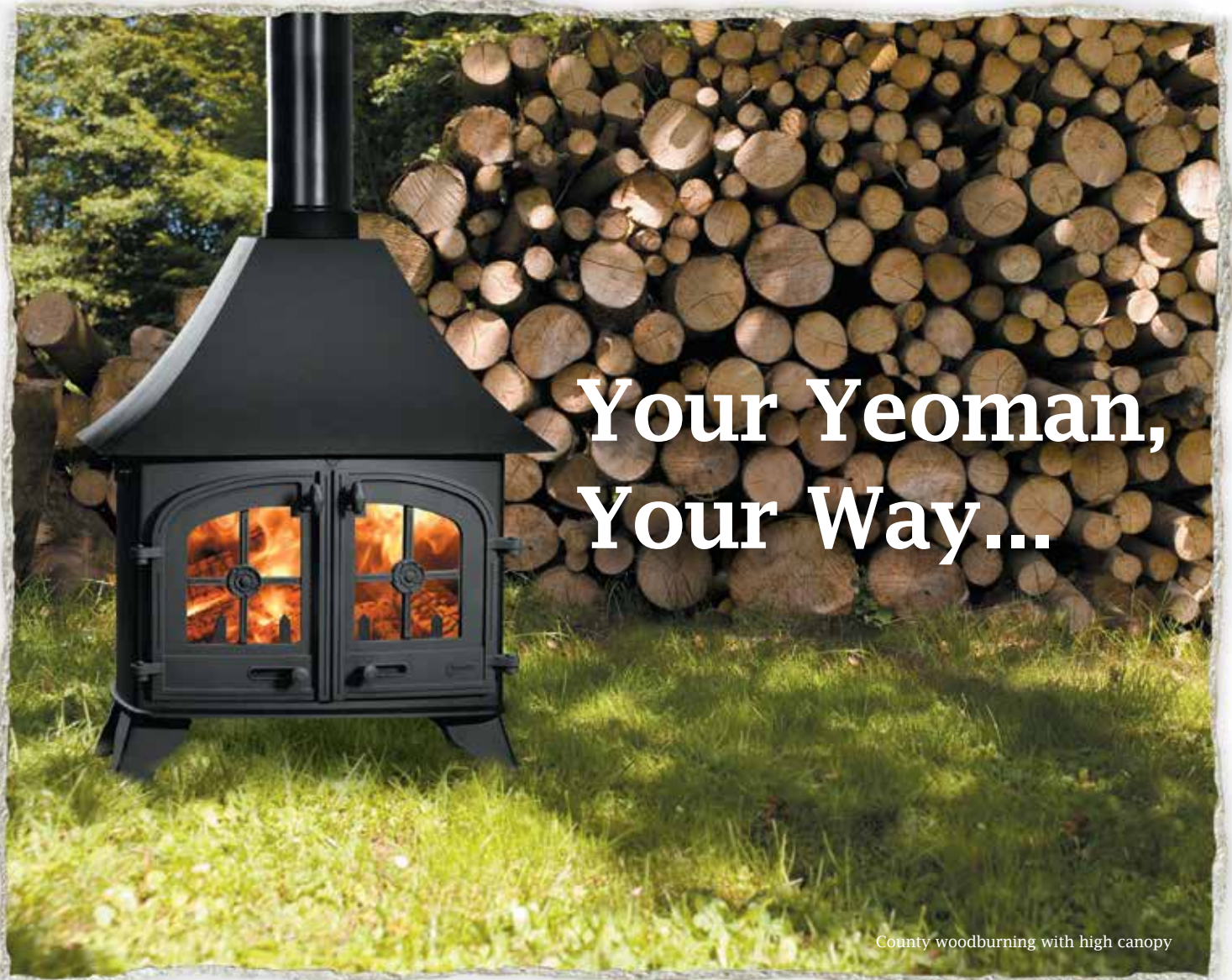

County woodburning with high canopy

Wood & Multi-fuel Stoves

All Yeoman stoves are designed to burn wood and smokeless fuels and have been independently tested to exacting standards for both heating efficiency and emissions.



The Exmoor, Exe, Devon, CL3, CL5, CL5 Wide, CL7 & CL Milner models are also approved for the burning of wood in DEFRA Smoke Control Areas when fitted with a smoke control kit, details can be found on the relevant product pages.

Wood – Wood is widely recognised as a natural, environmental friendly and virtually carbon neutral fuel. When burnt, the amount of carbon dioxide released into the atmosphere is approximately the same as that absorbed by the tree during growth. Wood is also a renewable resource, particularly when derived from plantations and cultivated woodland.

For optimum results, we recommend logs should be seasoned for 2 years or more to achieve a moisture content below 20%. This will not only give a higher output than that of freshly felled timber, it will also help avoid a build-up of tar in your flue. Furthermore, if you can obtain hardwood logs this is better still, as they will have a greatly increased calorific value compared to softwoods for the same volume.

Solid fuels – anthracite and manufactured smokeless fuels can be burnt on multi-fuel stoves or woodburning models with the addition of a multi-fuel kit. Multi-fuel stoves have a riddling grate which allows ash to be riddled into a built-in ashpan to create the optimum conditions for efficient combustion. Please note, however, that petroleum based fuels must never be used on your stove.

Boiler Stoves

Several Yeoman Woodburning/Multi-fuel stoves are designed to be fitted with optional boiler systems and details of these can be found on appropriate pages. Additionally, Yeoman offer a selection of High-Output Boiler models that come with the boiler built in. Please see pages 32-37 for details.



Styling options

The look of your stove is very important. That is why Yeoman offers you the opportunity to personalise your stove with a variety of styling options. According to model, these include flat top and high or low canopies as well as panoramic single and double doors with removable window crosses.

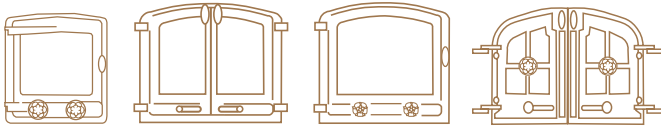

**Information for boiler options is a guide only. Seek advice and a site survey from a qualified heating engineer before ordering.*

***All stoves shown with this symbol boast the advantage of not normally requiring an air vent ^Δ where the air permeability is greater than 5.0m³/hr/m². Ventilation normally required is 550mm². Please discuss in full with your local retailer. ^ΔRequirements in the Republic of Ireland are different.*

Colour options

Colour is another option, with a choice of 4 paint finishes available for most stoves: Matt Black, Metallic Blue, Metallic Brown or Metallic Green. CL Stoves are finished in Metallic Black †.



Key to symbols

	Flat Top		Maximum Efficiency
	Low Canopy		Boiler Output*
	High Canopy		Vent not normally required**
	Nominal Heat Output and Range		Radiator Capabilities



CL8 Woodburning

High Efficiency

All Yeoman stoves have been designed to burn with high thermal efficiency, minimising the loss of heat energy during combustion. Every model in this brochure is subject to European energy labelling standards and a great many are rated as either A or A+ energy class appliances. Energy class and efficiency information is listed on each stove's product page for easy reference.

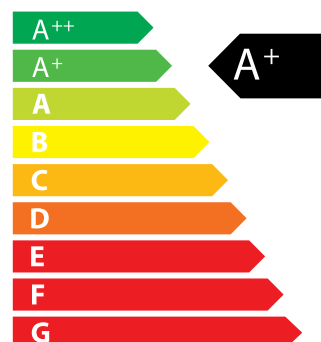



Complete Peace of Mind

Yeoman Extended Warranty



Your Yeoman Expert Retailer will provide you with a Two Year Warranty for your new solid fuel stove. This can then be extended to a Five Year Warranty provided it is registered with Yeoman. Please note, these warranties exclude certain consumable parts. Stoves purchased outside of Yeoman's Expert Retailer Network will carry a standard One Year Non-Extendable Warranty. Full warranty terms & conditions are available to view at www.yeomanstoves.co.uk.

Quality you can trust

Yeoman is part of the Stovax Heating Group, which is an ISO9001 and ISO14001 accredited company. Our rigorous quality control system ensures that all our appliances are safety checked and that they comply with the appropriate regulations, with all fires in this brochure bearing the CE mark. Similarly, our environmental management systems ensure we work in a sustainable manner, whilst endeavouring to protect the environment by minimising any possible impact from our operations.



Expert Retailer Network

To help you select the right stove for your home, you will find our useful reference symbols throughout the brochure (explained on previous pages). However, your Yeoman retailer will be pleased to provide any further information and advice you may require. We take great care to ensure that our stoves & fires are designed, tested and manufactured to the highest possible quality and safety standards. We are just as concerned to make certain that they are sold and installed correctly so that you enjoy years of pleasure from your purchase.

Accordingly, you will find our products are only available from experienced, independent retailers who will enable you to see a selection of models locally in their showrooms, often fully operational. These independent retailers will discuss your individual requirements both technical (such as sizing the heat output to your room and advising on your flue type) and design, and ensure that you select the most appropriate product for your home.

They will also be able to advise on or assist with the installation process as well as help provide any after sales support and servicing your appliance may require in the future.

Whilst we encourage our retailers to promote fireplace products and their outlets via the internet, we do not believe suitable levels of customer care and satisfaction can be obtained from nationwide online sales and we would strongly recommend that you consider this when undertaking your research and making a purchasing decision. Further, please be aware that we do not offer technical support (beyond our statutory responsibilities) to products bought via nationwide online sales, where this support would normally be offered by one of our qualified, independent retailers.



Yeoman fires and stoves purchased from within our Expert Retailer Network will have the additional benefit of a greatly extended warranty period, subject to terms and conditions. Full details can be found at www.yeomanstoves.co.uk.



Exmoor multi-fuel with flat top

Exmoor - neat and compact for the smaller room

Exmoor

Wood and Multi-fuel Stoves



Particularly suited to smaller rooms, the classically styled Exmoor is designed to fit neatly into a traditional 'builder's opening'. The gently curved front and sides give this model a solid, well proportioned appearance and one which can enhance both traditional and contemporary settings. A curved glass window also provides an excellent view of the flames.



Exmoor multi-fuel with low canopy

- Woodburning and multi-fuel models
- External riddling†
- Optional multi-fuel kit for woodburning models
- Cleanburn - the tertiary air system provides greater fuel efficiency (Wood: 78%, Smokeless fuel: 85%)
- Yeoman Airwash System – to give a clearer view of the flames
- Top or rear flue – 128mm (5")
- DEFRA Approved for Smoke Control Areas*
- Gas & Electric models also available, please see separate brochure

† Multi-fuel version

* Multi-fuel version, when fitted with Smoke Control Kit and used in accordance with operating instructions

 Find your nearest retailer
www.yeomanstoves.co.uk

					Energy Efficiency Class
Exmoor 	✓	✓	×	4.9kW (2.5 - 7kW)	

Available Colour Options

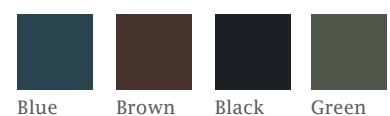

Blue

Brown

Black

Green



HIGH EFFICIENCY
UP TO 85% 



Exe multi-fuel double door with low canopy

Exe - ultimate versatility with optional boiler

Exe

Wood and Multi-fuel Stoves



Compact yet versatile, the Exe offers you an extensive choice of styling options as well as an optional boiler that can provide domestic hot water. It features Yeoman's Cleanburn system too, so you will enjoy improved fuel efficiency and a greater control of combustion. Furthermore, being a nominal 4.9kW output, no air vent^Δ is needed when the Exe is installed.



Exe multi-fuel double door with flat top with Tudor Rose door crosses removed

- Woodburning and multi-fuel models
- External riddling[†]
- Optional multi-fuel kit for woodburning models
- Cleanburn - the tertiary air system provides greater fuel efficiency (Wood: 78%, Smokeless fuels: 85%)
- Yeoman Airwash System – to give a clearer view of the flames
- Single or double door options
- Removable Tudor Rose door crosses*
- Optional boiler – for domestic hot water or supplementary central heating
- Top or rear flue – 153mm (6")
- Choice of extras – including spark guard*
- DEFRA Approved for Smoke Control Areas**
- Double-Sided versions also available, see pages 38 - 39
- Gas models also available, please see separate brochure

					Energy Efficiency Class	
Exe	✓	✓	×	4.9kW (2.5 - 7kW)	A	1.6kW 8500BTU

Available Colour Options



Blue Brown Black Green



HIGH EFFICIENCY
UP TO 85%

[†] Multi-fuel version * Double door only

** Multi-fuel version, when fitted with Smoke Control Kit and used in accordance with operating instructions

Δ In properties where air permeability is greater than 5.0m³/hr/m²



Find your nearest retailer
www.yeomanstoves.co.uk



Devon - at home in both traditional and modern settings

Devon

Wood and Multi-fuel Stoves



The Devon is a highly popular, medium sized stove which can be tailored to look equally at home in the fireplace of a modern house or the inglenook of a country cottage. It also offers an impressive heat output of up to 9kW whether burning logs, anthracite or smokeless fuels.



Devon multi-fuel single door with flat top.
See front cover for additional image.

- Woodburning and multi-fuel models
- External riddling†
- Optional multi-fuel kit for woodburning models
- Cleanburn - the tertiary air system provides greater fuel efficiency (Wood: 81%, Smokeless fuels: 78%)
- Yeoman Airwash System – to give a clearer view of the flames
- Single or double door options
- Removable Tudor Rose door crosses*
- Optional boiler – for domestic hot water
- Top or rear flue – 153mm (6")
- Choice of extras – including spark guard*
- DEFRA Approved for Smoke Control Areas**
- Double-Sided and integral high output boiler versions available, see pages 32 - 37 & 38 - 39
- Gas models also available, please see separate brochure

					Energy Efficiency Class	
Devon	✓	✓	✓	9kW (4 - 11kW)	A+	3.5kW 12000BTU

† Multi-fuel version * Double door only

** Multi-fuel version, when fitted with Smoke Control Kit and used in accordance with operating instructions

Available Colour Options

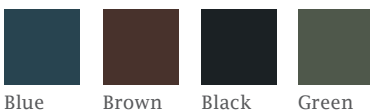

Blue Brown Black Green



Find your nearest retailer
www.yeomanstoves.co.uk

County

Wood and Multi-fuel Stoves



The largest of our traditional stoves, the County has the proportions to grace any inglenook and the performance to provide a magnificent focal point in larger rooms and open living spaces. The vast firebox is designed to accept logs up to 460mm (18”) long, so that you do not need to load fuel so often. It also has the potential to produce considerable heat output.



County woodburning single door with flat top

Please see additional image on page 4

- Woodburning stove
- Optional multi-fuel kit
- Cleanburn - the tertiary air system provides greater fuel efficiency (Wood: 78%, Smokeless fuels: 84%)
- Yeoman Airwash System – to give a clearer view of the flames
- Single or double door options
- Removable Tudor Rose door crosses*
- Optional boiler – for domestic hot water
- Top or rear flue – 153mm (6”)
- Large combustion chamber for logs up to 460mm (18”) in length
- Double-Sided and integral high output boiler versions available, see pages 32 - 37 & 38 - 39

* Double door only

^ County Double Door: A / County Single Door: B



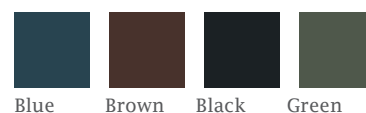

 Find your nearest retailer
www.yeomanstoves.co.uk

Available Colour Options



Blue Brown Black Green



					Energy Efficiency Class	
County	✓	✓	✓	13kW (7 - 16kW)	A [^]	7.0kW 24000BTU

HIGH EFFICIENCY
UP TO 84% 



County woodburning double door with low canopy

County - our largest stove with an impressive heat output

CL3

Multi-fuel Stove







Designed to be equally at home in either a traditional setting or today's more modern interiors, Yeoman's woodburning and multi-fuel CL range of stoves are an eye-catching focal point. Housed within the stylish exterior, advanced heating technology ensures high efficiency and combustion of logs or smokeless fuel. The smallest in the series, the CL3 makes a big impression despite its compact proportions. To complement the gentle curves of the stove front, a decorative cast top plate is supplied with each of the CL stoves.



CL3 multi-fuel

Please see additional image on page 5

- Multi-fuel model
- External riddling
- Cleanburn - the tertiary air system provides greater fuel efficiency (Wood: 77%, Smokeless fuels: 86%)
- DEFRA Approved for Smoke Control Areas*
- Yeoman Airwash System – to give a clearer view of the flames
- Decorative cast top plate
- Top or rear flue – 128mm (5")
- Levelling system
- Stainless steel handle with self locking function
- Contemporary screen printed ceramic glass
- Integral raised plinth
- High performance firebox lining to enhance combustion process
- Heavy duty steel construction
- Primary air control
- Gas & Electric models also available, please see separate brochure

			Energy Efficiency Class
CL3		3.75kW (2 - 5kW)	

HIGH EFFICIENCY UP TO 86% 



Metallic Black



* When fitted with Smoke Control Kit and used in accordance with operating instructions



Find your nearest retailer
www.yeomanstoves.co.uk



CL3 multi-fuel

CL3 - small stove, big impression



CL5 woodburning

CL5 - high efficiency heating and 'modern traditional' styling

CL5

Wood and Multi-fuel Stoves







With high efficiency and 'modern traditional' styling, the CL5 offers a fresh alternative for heating in today's homes. Along with the smaller CL3, the CL5 is approved for use in Smoke Control zones, so you can achieve carbon neutral heating with wood wherever your location! It is available in two versions: woodburning only or multi-fuel which incorporates a riddling grate to allow the burning of smokeless fuels. In addition, both versions are enhanced by the decorative cast top which provides subtle elegance with its minimal curved form.



- Woodburning and Multi-fuel models
- External riddling†
- Cleanburn - the tertiary air system provides greater fuel efficiency (Wood: 80%, Smokeless fuels: 85%)
- Yeoman Airwash System – to give a clearer view of the flames
- DEFRA Approved for Smoke Control Areas*
- Decorative cast top plate
- Top or rear flue – 128mm (5")
- Levelling system
- Stainless steel handle with self locking function
- Contemporary screen printed ceramic glass
- Integral raised plinth
- High performance firebox lining to enhance combustion process
- Heavy duty steel construction
- Primary air control
- Gas & Electric models also available, please see separate brochure

Please also see image on back cover

			Energy Efficiency Class
CL5		4.9kW (2.5 - 7kW)	

HIGH EFFICIENCY UP TO 85% 



Metallic Black



† Multi-fuel version

* When fitted with Smoke Control Kit and used in accordance with operating instructions



Find your nearest retailer
www.yeomanstoves.co.uk

CL5 Midline





Multi-fuel Stove



One of the latest additions to the Yeoman range, the new CL5 Midline has been designed with an integrated log store and like all CL Stoves features a subtly curving cast iron top plate. Available as a multi-fuel model only, the Midline features the same advanced Airwash and Cleanburn technology as the CL5 whilst providing an impressive 5kW heat output. The Midline offers a real style statement whilst providing a functional space-saving option for your home.



- Multi-fuel model with external riddling
- Cleanburn - the tertiary air system provides greater fuel efficiency (Wood: 80%, Smokeless fuels: 85%)
- Yeoman Airwash System – to give a clearer view of the flames
- DEFRA Approved for Smoke Control Areas*
- Integral log store
- Decorative cast top plate
- Top or rear flue – 128mm (5")
- Levelling system
- Stainless steel handle with self locking function
- Contemporary screen printed ceramic glass
- High performance firebox lining to enhance combustion process
- Heavy duty steel construction
- Primary air control

			Energy Efficiency Class
CL5 Midline 	✓	4.9kW (2.5 - 7kW)	

HIGH EFFICIENCY UP TO 85% 

* When fitted with Smoke Control Kit and used in accordance with operating instructions



Metallic Black



Find your nearest retailer
www.yeomanstoves.co.uk

Registered Design: Community Design
Application Number: 001202600



CL5 Midline

CL5 Midline - smooth, curving lines to create a real style statement



CL5 Highline

CL5 Highline - form and function combined.

CL5 Highline

Multi-fuel Stove







Combining both form and function, the new CL5 Highline provides the same features and characteristics of the CL5 multi-fuel stove with a substantial log store integrated into the 'modern-traditional' design. The Highline provides a warming and impressive focal point in kitchens and open plan rooms.

Available in a Metallic Black finish with striking stainless steel detailing, the CL5 Highline features a subtly curving cast top as standard and offers an excellent view of the rolling flames due to the elevated firebox.



CL5 Highline

See back cover for additional image.

			Energy Efficiency Class
CL5 Highline 	✓	4.9kW (2.5 - 7kW)	

HIGH EFFICIENCY
UP TO 85% 

- Multi-fuel model with external riddling
- Cleanburn - the tertiary air system provides greater fuel efficiency (Wood: 80%, Smokeless fuels: 85%)
- Yeoman Airwash System – to give a clearer view of the flames
- DEFRA Approved for Smoke Control Areas*
- Integral log store
- Decorative cast top plate
- Top or rear flue – 128mm (5")
- Levelling system
- Stainless steel handle with self locking function
- Contemporary screen printed ceramic glass
- High performance firebox lining to enhance combustion process
- Heavy duty steel construction
- Primary air control

* When fitted with Smoke Control Kit and used in accordance with operating instructions



Metallic Black



Find your nearest retailer
www.yeomanstoves.co.uk

CL5 Wide





Wood & Multi-fuel Stoves



The CL5 Wide prioritises flame visuals, featuring a broad front and expansive viewing window for an impressive display. Yet, thanks to its shallow depth, this slimline stove is an excellent choice for standard room sizes, providing a nominal 5kW heat output. Internal combustion systems employ advanced cleanburn technology for DEFRA smoke control exemption, making the CL5 Wide a great choice for rural or urban homes alike. Woodburning as standard, this versatile model can be fitted with an optional multi-fuel kit to burn smokeless fuels if required.



- Woodburning stove
- Optional multi-fuel kit
- Cleanburn - the tertiary air system provides greater fuel efficiency (Wood: 79%, Smokeless fuels: 79%)
- Yeoman Airwash System – to give a clearer view of the flames
- DEFRA Approved for Smoke Control Areas
- Decorative cast top plate
- Top or rear flue – 128mm (5")
- Levelling system
- Stainless steel handle with self-locking function
- Contemporary screen printed ceramic glass
- High performance firebox lining to enhance combustion process
- Heavy duty steel construction
- Primary air control & secondary air control with stainless control
- Shallow depth

			Energy Efficiency Class
CL5 Wide 	✓	5.0kW (2.5 - 7kW)	

HIGH EFFICIENCY
UP TO 79% 



Find your nearest retailer
www.yeomanstoves.co.uk



Metallic
Black





CL5 Wide. Shown with Stovax Cavendish Bolection Limestone mantel.

CL5 Wide - A 5kW stove with expansive flame visuals and slim depth

CL8

Wood and Multi-fuel Stoves



The largest of the CL range, the CL8 is designed to provide high efficiency heating as well as creating an outstanding focal point for your living space. Choose from either the woodburning only model or the multi-fuel version, the latter incorporating a riddling grate to allow you to burn smokeless fuels. The decorative cast top completes the CL8's already impressive visual impact.





CL8 multi-fuel

- Woodburning and Multi-fuel models
- External riddling†
- Cleanburn - the tertiary air system provides greater fuel efficiency (Wood: 76%, Smokeless fuels: 81%)
- Yeoman Airwash System – to give a clearer view of the flames
- Decorative cast top plates
- Top or rear flue – 153mm (6")
- Levelling system
- Stainless steel handle with self locking function
- Contemporary screen printed ceramic glass
- Integral raised plinth
- High performance firebox lining to enhance combustion process
- Heavy duty steel construction
- Primary air control
- High output boiler version, pages 36 - 37
- Gas models also available, please see separate brochure

† Multi-fuel version

Further image on page 6.

			Energy Efficiency Class
CL8	✓	8kW (4 - 11kW)	

HIGH EFFICIENCY UP TO 81% 



Metallic Black



Find your nearest retailer
www.yeomanstoves.co.uk



CL8 woodburning.

CL8 - an outstanding focal point for your living space

CL7 Inset

Multi-fuel Inset Fire





The CL7 Inset is the first contemporary inset fire in the Yeoman range and expands the opportunities to incorporate the highly desirable decorative styling of the CL range into a larger variety of homes and interiors. Convenient and highly efficient, the cutting edge Airwash System keeps the window clear so that you can always enjoy the atmospheric flicker of the CL7 Inset's superb flame picture.



CL7 Inset multi-fuel

- Multi-fuel
- External riddling
- Cleanburn - the tertiary air system provides greater fuel efficiency (Wood: 78%, Smokeless fuels: 87%)
- Yeoman Airwash System – to give a clearer view of the flames
- DEFRA Approved for Smoke Control Areas*
- Top flue exit only– 128mm (5")
- Stainless steel handle with self locking function
- Contemporary screen printed ceramic glass
- Integral raised plinth
- High performance firebox lining to enhance combustion process
- Heavy duty steel construction
- Primary air control

* When fitted with Smoke Control Kit and used in accordance with operating instructions

			Energy Efficiency Class
CL7 Inset	✓	7kW (3 - 8kW)	

HIGH EFFICIENCY
UP TO 87% 

 Find your nearest retailer
www.yeomanstoves.co.uk



Metallic Black



Registered Design: Community Design
Application Number: 001202600



CL7 Inset multi-fuel

CL7 Inset - modern style and space saving

CL Milner

Multi-fuel Inset Fire



The CL Milner has been designed with high performance and ease of installation in mind. The CL Milner has the ability to be installed into a 16” - 18” wide and 20” - 22” high fireplace without the need to remove the Milner Brick; meaning that it can be easily secured and sealed into an existing chimney without the requirement for any building work making it cheaper to install. There is also no need for a flue liner, therefore if your chimney is in good condition and has been swept it can generally be fitted in under an hour!

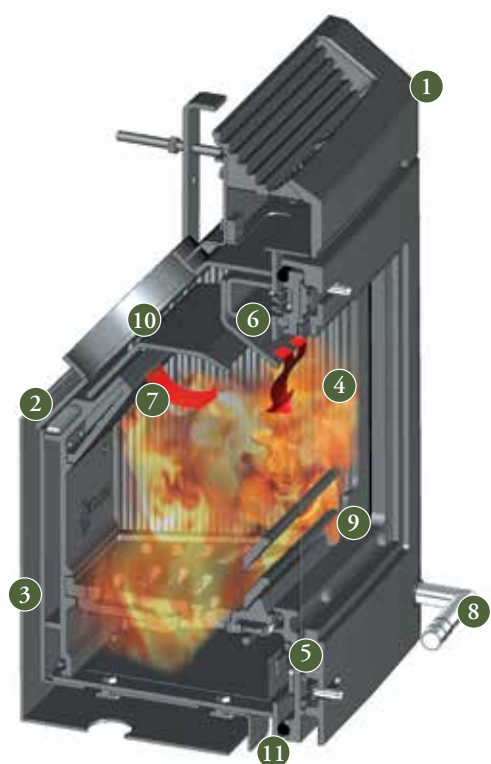

CL Milner Design Features





- 1 5mm heavy duty steel construction
- 2 Easy fit
- 3 Specifically designed for 16” and 18” Milner brick openings
- 4 High performance firebox lining to enhance combustion process
- 5 Cast iron air-tight door with primary air control lever
- 6 Yeoman Airwash System – to give a clearer view of the flames
- 7 Cleanburn - the secondary air system provides greater fuel efficiency (Wood: 76%, Smokeless fuels: 81%)
- 8 Stainless steel handle with self locking function
- 9 Contemporary screen printed ceramic glass
- 10 Top flue exit only – 152mm (6”)
- 11 Adjustable secondary air control
- 12 DEFRA Approved for Smoke Control Areas* (not illustrated)

* When fitted with Smoke Control Kit and used in accordance with operating instructions



Find your nearest retailer
www.yeomanstoves.co.uk

Registered Design: Community Design
 Application Number: 001202600

			Energy Efficiency Class
CL Milner 	✓	5kW (2 - 6kW)	



Metallic Black





CL Milner multi-fuel. Shown with Stovax Brompton wooden mantel in white.

CL Milner – quick and hassle-free installation

High-Output Boilers

Woodburning & Multi-fuel Boiler Stoves

Four models within the range have been specifically designed to supply your domestic hot water and central heating requirements or augment your existing heating system via 'link up' technology. Whichever your choice, you will enjoy all the atmosphere of a real fire and exceptional heating performance for other areas of your home.









When providing hot water and central heating, each stove is capable of feeding an average 8000BTU hotwater cylinder and from 8 up to 19 radiators. The exact number of radiators will depend upon how many rooms you wish to heat and sizes of those rooms. Radiators also come in a variety of sizes/capacities but, for example, a typical 400mm high x 1000mm wide, single panel radiator requires 2500BTU/hr. You should always consult a qualified heating engineer to ensure the stove can meet your requirements.

Alternatively, you can 'link up' a Yeoman High-Output Boiler with your existing or proposed heating system to reduce your reliance on gas or oil and help decrease overall heating fuel costs. There are ways to link with conventional oil or gas central heating, gas or oil sealed heating systems, combi boilers, underfloor heating and even solar panels to provide flexible and cost-effective solutions. Yeoman produces a 'link up' guide showing typical arrangements and covering some frequently asked questions. You may find it useful to download this from



www.yeomanstoves.co.uk/linkup before discussing your requirements with a qualified heating engineer.

All Yeoman High-Output Boiler stoves are designed for multi-fuel use and incorporate an externally operated riddling grate. This is because solid mineral fuels tend to provide greater calorific values. Should you wish to reduce your CO₂ emissions then you can also burn a combination of smokeless fuels and logs together. However, if woodburning only is your preference, you can still achieve good performance but, as logs burn best with slightly different firebox characteristics, we recommend you purchase the optional log tray which replaces the riddling system on multi-fuel models or the dedicated woodburning only models for the County 60HB and 80HB.

		 Nominal Heat Output		Energy Efficiency Class		 *
Devon 50HB	✓	13.0kW(WB) 14.0kW(MF)	70%(WB) 72%(MF)		10.0kW 34,000BTU	9 [^]
County 60HB	✓	17.0kW	69%(WB) 72%(MF)		13.0kW 45,000BTU	15 [^]
County 80HB	✓	25.0kW(WB) 21.0kW(MF)	66%(WB) 72%(MF)		18.0kW 62,000BTU	19 [^]
CL8HB	✓	13.0kW(WB) 14.0kW(MF)	70%(WB) 72%(MF)		10.0kW 34,000BTU	9 [^]

Devon and County Colour Options



Blue Brown Green Black

CL8HB Colour



Metallic
Black

[^] Includes 8000 BTU allowance for hot water cylinder.

* Please see comments on radiator capabilities above and on page 34 and 37, as these are a guide only.



Devon 50HB

Devon and County Boiler Design Features

- 1 5mm and 10mm heavy duty steel body.
- 2 Excellent heat output to water when burning solid fuels or wood.
- 3 4 x 1" BSP boiler tappings for flexible efficient connection to your hot water circuits.
- 4 Extensive water jacket on 4 sides of stove to ensure maximum transmission of heat to water.
- 5 Highly developed boiler flue baffle system to ensure maximum heating efficiency.
- 6 Top or rear flue exit.
- 7 Specially designed reciprocating grate ensures effective removal of ash from the fuel bed.*
- 8 Large ash collection tray.
- 9 Discreet external riddling socket, with removable tool.*
- 10 Unique heated air jets from cleanburn ports burn hydrocarbons in smoke. (UK Patent Application GB2495920)
- 11 Levelling system in each foot to ensure complete stability on uneven surfaces.
- 12 Primary air controls to manually adjust the running temperatures.
- 13 Airwash helps to keep the glass clear and to control the running temperature when burning wood.
- 14 Thermostatic control to maintain desired running temperatures.
- 15 Removable Tudor Rose door crosses.
- 16 Optional woodburning tray for multi-fuel models (not illustrated).



**Multi-fuel models only.*

High-Output Boilers

Devon & County Woodburning & Multi-fuel Boiler Stoves



County 60HB

Key Facts:	Devon 50HB	County 60HB	County 80HB
Multi-fuel with external riddling	✓	✓	✓
Dedicated woodburning version	✗	✓	✓
Airwash	✓	✓	✓
Unique Cleanburn System (UK Patent Application GB2495920)	✓	✓	✓
CE Approved	✓	✓	✓
Nominal heat output to room	6.0kW	6.0kW	11.0 (WB) / 7.0kW (MF)
Nominal heat output to boiler	7.0 (WB) / 8.0kW (MF)	11.0kW	14.0kW
Maximum system rating	10kW (34,000BTU)	13kW (45,000BTU)	18kW (62,000BTU)
Efficiency	70% (WB) / 72% (MF)	69% (WB) / 72% (MF)	66% (WB) / 72% (MF)
Energy Efficiency Class	A	A	B
Radiator capabilities - example No. of 2500BTU radiators + 8000BTU cylinders*	9 radiators	15 radiators	19 radiators
Maximum log length	15 ³ / ₄ " (400mm)	19 1/2" (500mm)	23 1/2" (600mm)
Optional log tray	✓	✓	✓
Flue outlet	6" top or rear	6" top or rear	6" top or rear
Choice of four colours	✓	✓	✓
Thermostatic Control	✓	✓	✓

*Please note that radiator capabilities are a guide only. We strongly recommend you have a site survey and advice from an appropriately qualified heating engineer before ordering.



County 80HB - exceptional output for whole house heating



CL8HB - complete home heating with cutting edge style!

High-Output Boilers

CL8 Multi-fuel Boiler Stove

Design Features

- 1 5mm and 8mm heavy duty steel body.
- 2 Excellent heat output to water when burning solid fuels or wood.
- 3 4 x 1" BSP boiler tappings for flexible efficient connection to your hot water circuits.
- 4 Extensive water jacket on 4 sides of stove to ensure maximum transmission of heat to water.
- 5 Highly developed boiler flue baffle system to ensure maximum heating efficiency.
- 6 Top or rear flue exit.
- 7 Specially designed reciprocating grate ensures effective removal of ash from the fuel bed.
- 8 Large ash collection tray.
- 9 Discreet external riddling socket, with removable tool.
- 10 Unique heated air jets from cleanburn ports burn hydrocarbons in smoke (UK Patent Application GB2495920).
- 11 Levelling system to ensure complete stability on uneven surfaces.
- 12 Primary air controls to manually adjust the running temperatures.
- 13 Airwash helps to keep the glass clear and to control the running temperature when burning wood.
- 14 Cast iron top plates in top & rear flue.
- 15 Stainless steel door handle, with self-locking function.
- 16 Thermostatic control to maintain desired running temperatures (not illustrated).
- 17 Optional woodburning tray (not illustrated).

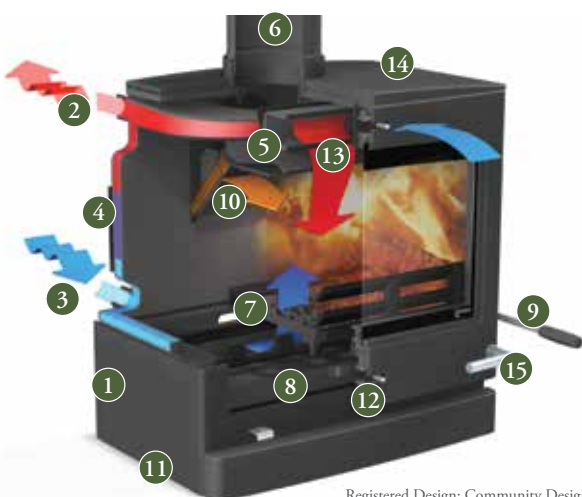

Registered Design: Community Design
Application Number: 001202600

Key Facts:

	CL8HB
Multi-fuel with external riddling	✓
Airwash	✓
Unique Cleanburn System (UK Patent Application GB2495920)	✓
CE Approved	✓
Nominal heat output to room	6.0kW
Nominal heat output to boiler	7.0 (WB) / 8.0kW (MF)
Maximum system rating	10kW (34,000BTU)
Efficiency	70% (WB) / 72% (MF)
Energy Efficiency Class	A
Radiator capabilities - example No. of 2500BTU radiators + 8000BTU cylinders*	9 radiators
Maximum log length	15 ³ / ₄ " (400mm)
Optional log tray	✓
Flue outlet	6" top or rear
Thermostatic Control	✓
Decorative cast top plate (top & rear flue versions)	✓

* Please note that radiator capabilities are a guide only. We strongly recommend you have a site survey and advice from an appropriately qualified heating engineer before ordering.



Exe Double-Sided - the warming heart of your home

Double-Sided

Wood and Multi-fuel Stoves

There can be few sights as inviting or reassuringly evocative, especially on a cold winter's night, as the roaring fire of a Yeoman double-sided stove turning two rooms into the warming heart of your home. With a Yeoman Double you enjoy twice the stove. Doors front and back are designed to open into adjoining rooms with one central chimney. You can choose from Exe, Devon and County models and from single or double depth versions. Each model also has a number of styling options to complement your decor.



- Top flue - 153mm (6")
- Suitable for burning wood or multi-fuel[#]
- Yeoman Airwash System – to give a clearer view of the flames
- Optional spark guards^{*}
- Single or double door options (depending on model)
- Removable Tudor Rose door crosses^{*}
- Single or double depth versions (depending on model)

^{*} Double door - Devon & Exe only. County has crosses, but no spark guard

[#] With the use of a multi-fuel kit (except County Double Depth which is woodburning only)

Available Colour Options

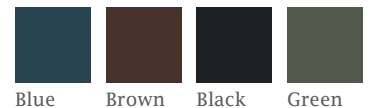

Blue Brown Black Green



	Depth	Doors				Wood [†]	Wood	Energy Efficiency Class	MF kit [†]	MF kit
Exe	Double	1 or 2	✓	×	×	11.0kW	69%		8.0kW	79%
Devon	Single	1 or 2	✓	✓ [*]	×	9.0kW	69%		9.0kW	66%
Devon	Single	2	×	×	✓	9.0kW	69%		9.0kW	66%
Devon	Double	1	×	✓	×	13.0kW	65%		12.0kW	66%
Devon	Double	2	×	×	✓	13.0kW	65%		12.0kW	66%
County	Single	2	✓	✓	✓	15.0kW	66%		15.0kW	60%
County	Double	2	✓	✓	✓	22.0kW	72%		n/a	n/a

^{*} Single Door only. [†] Nominal Heat Output

Accessories & Flue Pipe



Care of your Stove or Fireplace

Yeoman is a member of the Stovax Group which manufactures and distributes many other high quality fireplace, stove care and accessory products, as well as solid fuel, gas and electric fires and stoves. To help maximise the enjoyment from your stove or fireplace and keep it in good condition, inside and out please ask your Yeoman retailer for a Stovax accessories brochure or view the complete range online at www.stovax.com.



Contemporary Steel Log Holders and Tool Sets

For more modern interiors, Stovax has developed a range of contemporary log holders and stove tool sets crafted in matt black steel and stainless steel. These are highly attractive and a superb pairing to Yeoman's range of CL stoves and fires in particular.



Professional XQ™ Chimney Systems

The Stovax Group also offer a comprehensive range of stove & fireplace chimney systems, the Stovax Professional XQ™ collection. Crafted from 304L grade stainless steel for a durable outer finish, the fully sealed components offer water tight protection for the insulation within. With innovative decorative options, the ability to specify a colour for your system and with a host of technical advancements such as their Twist-Lock system, the

Professional XQ™ range provides an attractive, versatile and reliable solution for your flue system. Furthermore, the Professional XQ™ range carries a 10 year conditional warranty offering complete peace of mind. For further information, please speak to your retailer or visit www.stovax.com/chimneysystems.



Technical Information

Product Improvement, Photography and Safety Information

Yeoman pursue a policy of constant product improvement. Products supplied may therefore differ in specification from those illustrated or described in this brochure, and you should always check the final specification with your Yeoman retailer.

All fire and flame photography has been taken from genuine products; however, the exact appearance of the flame picture for any appliance will vary depending on the nature of the flue type, installation surroundings, local geographical features and the way in which the appliance is operated.

Please note that all parts of these stoves and fires, particularly the glass panel in the door, become extremely hot during operation and can result in serious injury and burns if touched. It is therefore recommended that a fireguard complying with BS 8423:2002 is used in the presence of young children, the elderly or infirm. Furthermore, by law all installations also require a Carbon Monoxide monitor be present.

Extended Warranty

Your Yeoman Expert Retailer will provide you with a Two Year Warranty for your new solid fuel stove. This can then be extended to a Five Year Warranty provided it is registered with Yeoman. Please note, this warranty excludes certain consumable parts and are dependant on your appliance being serviced by an appropriately qualified person 12 months after installation and annually thereafter. Stoves purchased outside of Yeoman's Expert Retailer Network will carry a standard One Year Non-Extendable Warranty. Full warranty terms and conditions are available to view at www.yeomanstoves.co.uk.



Installing Your Yeoman Stove

In the UK, a HETAS approved installer should undertake a site survey prior to purchase and must install your Yeoman Stove for you. Your Yeoman Expert Retailer will be able to offer you advice on this. You may also view or download installation instructions at our website. All fires and stoves consume air as they burn. To comply with UK Building Regulations (Document J), therefore, if you are purchasing a stove with a maximum heat output in excess of 5.0kW, you will need to install a fixed air vent to ensure adequate ventilation. Outputs below this will not normally require a vent.

Yeoman Heat Shields

Yeoman has introduced a range of highly effective Heat Shields for the following stoves; Exmoor, Exe, CL3, CL5, CL5 Midline, CL5 Highline and CL5 Wide. These fantastic additions allow a reduction in the distance to combustible materials at the rear and sides of the stoves as shown below. The Yeoman Heat Shields not only maximise the available space within the room, but they also enable you to accommodate a wider range of materials in your interior design. For further information please speak to your local Yeoman retailer.

Distances to combustible materials when fitted with Yeoman Heat Shield[†]:

Stove	Distance from rear (mm)	Distance from sides (mm)
Exmoor	100	300
Exe	250	450
CL3	200	400
CL5	200	300
CL5 Midline	200	300
CL5 Highline	200	300
CL5 Wide*	300	300

* When installed with Twin Wall flue pipe

† Please see instruction manual for more information on distance to combustibles.



CL5 woodburning, shown with optional heat shield and Stovax Professional XQ Chimney System.

Technical Information

TRADITIONAL WOODBURNING AND MULTI-FUEL STOVES

EXMOOR

YM-EXM-W1	Woodburning, flat top, single door
YM-EXM-MF1	Multi-fuel, flat top, single door
YM-EXM-MFLC1	Multi-fuel, low canopy, single door
Options	
YM-EXM-MFKIT	Multi-fuel kit, external riddling
YM-EXM-HSK	Heat shield kit for Exmoor
YM-SZKITEXM	Smoke Control Kit for all Exmoor multi-fuel external riddling models
4227	Ash Caddy
BL/BR/GR	Coloured paint supplement, add BL (Metallic Blue), BR (Metallic Brown) or GR (Metallic Green) suffix to stove code

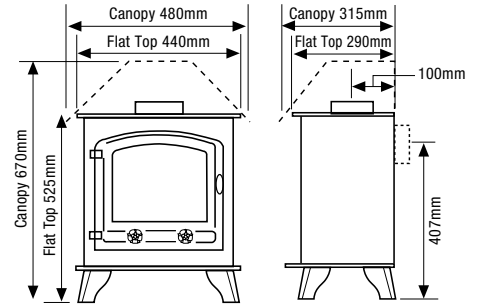

Approx. Weight: 64 - 68Kg

EXE

YM-EXE-W1	Woodburning, flat top, single door
YM-EXE-W2	Woodburning, flat top, double doors
YM-EXE-WLC1	Woodburning, low canopy, single door
YM-EXE-WLC2	Woodburning, low canopy, double doors
YM-EXE-MF1	Multi-fuel, flat top, single door
YM-EXE-MF2	Multi-fuel, flat top, double doors
YM-EXE-MFLC1	Multi-fuel, low canopy, single door
YM-EXE-MFLC2	Multi-fuel, low canopy, double doors
Options	
YM-EXE-MFKIT	Multi-fuel kit, external riddling
YM-EXE-HSK	Heat shield kit for Exe
YM-SZKITEXDV	Smoke Control Kit for all Exe multi-fuel external riddling models
YM-A9130	Boiler, stainless steel- 2.5kW (8500 BTU)
YM-A9902	Spark guard (suitable for double door Exe only)
4227	Ash Caddy
BL/BR/GR	Coloured paint supplement, add BL (Metallic Blue), BR (Metallic Brown) or GR (Metallic Green) suffix to stove code

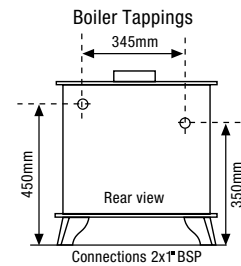
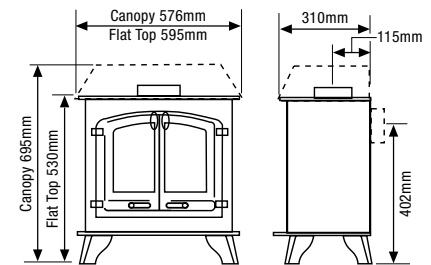

Approx. Weight: 94 - 100Kg

DEVON

YM-DEV-W1	Woodburning, flat top, single door
YM-DEV-W2	Woodburning, flat top, double doors
YM-DEV-WLC1	Woodburning, low canopy, single door
YM-DEV-WHC1	Woodburning, high canopy, single door
YM-DEV-WHC2	Woodburning, high canopy, double doors
YM-DEV-MF1	Multi-fuel, flat top, single door
YM-DEV-MF2	Multi-fuel, flat top, double doors
YM-DEV-MFLC1	Multi-fuel, low canopy, single door
Options	
YM-DEV-MFKIT	Multi-fuel kit, external riddling
YM-SZKITEXDV	Smoke Control Kit for all Devon multi-fuel external riddling models
YM-A9230	Boiler-3.5kW (12,000 BTU)
YM-A9902	Spark guard (suitable for double door Devon only)
4227	Ash Caddy
BL/BR/GR	Coloured paint supplement, add BL (Metallic Blue), BR (Metallic Brown) or GR (Metallic Green) suffix to stove code

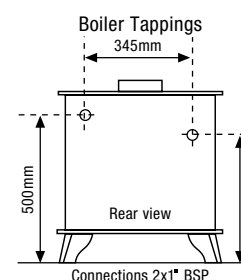
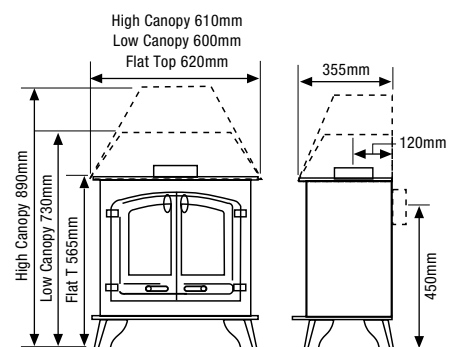

Approx. Weight: 102 - 118Kg

Technical Information

TRADITIONAL WOODBURNING & MULTI-FUEL STOVES (CONTINUED)

COUNTY

YM-COU-W1	Woodburning, flat top, single door
YM-COU-W2	Woodburning, flat top, double doors
YM-COU-WLC1	Woodburning, low canopy, single door
YM-COU-WLC2	Woodburning, low canopy, double doors
YM-COU-WHC1	Woodburning, high canopy, single door
YM-COU-WHC2	Woodburning, high canopy, double doors

Options

YM-COU-MFKIT	Multi-fuel kit
YM-A9330	Boiler-7kW (24,000 BTU)
4229	Ash Caddy
BL/BR/GR	Coloured paint supplement, add BL (Metallic Blue), BR (Metallic Brown) or GR (Metallic Green) suffix to stove code

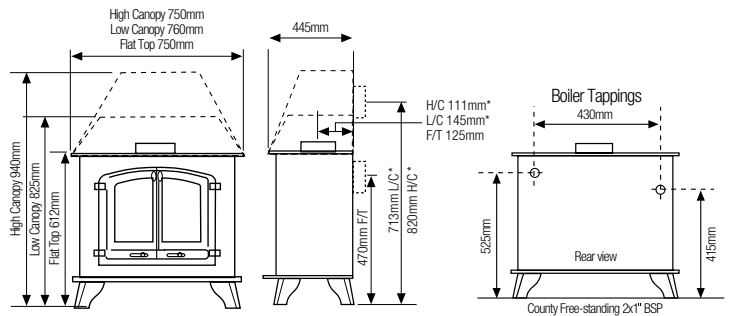

Approx. Weight: 124Kg

*The County has rear outlets in the stove and low/high canopies.

HIGH OUTPUT BOILER STOVES

CL8HB - High output boiler stove

YM-CL8HBMF1U	CL8HB Multi-fuel with universal cast top plate
--------------	--

Options

STATIN	Thermostat - CL8HB
8HBWT	Woodburning Tray - CL8HB
YM-CL8CT	Decorative cast top plate - CL8HB top flue
YM-CL8CTR	Decorative cast top plate - CL8HB rear flue

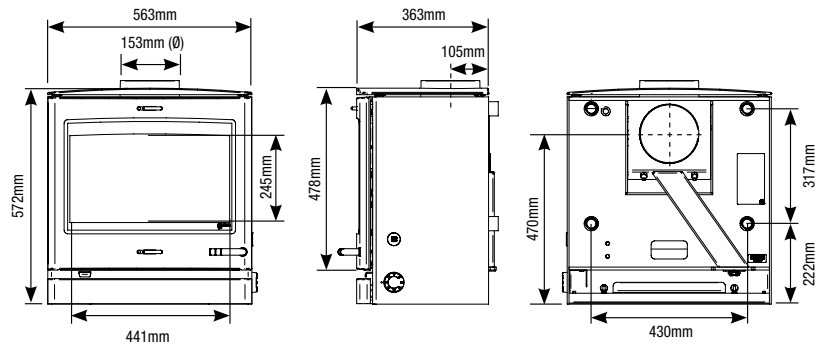

Approx. Weight: 130Kg

DEVON 50HB, COUNTY 60HB & COUNTY 80HB - High output boiler stoves

YM-DEV-50HBMF2	Devon 50HB, Multi-fuel, Flat top, Double door
YM-COU-60HBMF2	County 60HB, Multi-fuel, Flat top, Double door
YM-COU-80HBMF2	County 80HB, Multi-fuel, Flat top, Double door
YM-COU-60HBW2	County 60HB, Wood, Flat top, Double door
YM-COU-80HBW2	County 80HB, Wood, Flat top, Double door

Options

YM-DEV-50HBWT	Woodburning tray - 50HB
YM-COU-60HBWT	Woodburning tray - 60HB
YM-COU-80HBWT	Woodburning Tray - 80HB
YM-A9902	Spark guard (suitable for double door Devon only)

BL/BR/GR	Coloured paint supplement, add BL (Metallic Blue)* BR (Metallic Brown) or GR (Metallic Green) suffix to stove code
----------	--

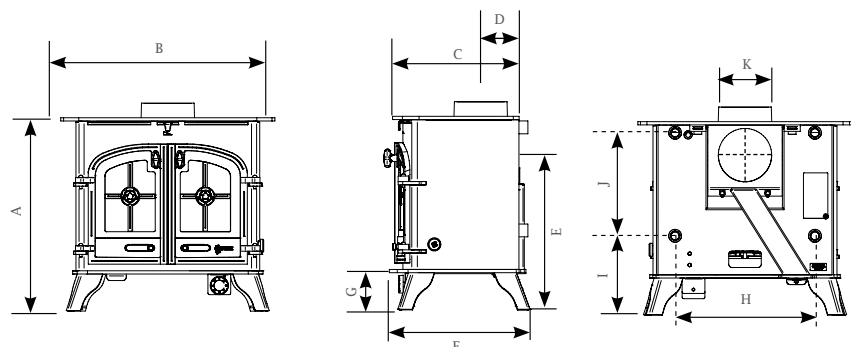

	A	B	C	D	E	F	G	H	I	J	K (Ø)	Weight
Devon 50HB	596	659	389	118	493	433	115	430	244	317	153	139kg
County 60HB	640	772	446	125	538	508	121	550	251	357	153	188kg
County 80HB	693	857	508	120	589	574	131	630	261	397	153	225kg

All above dimensions provided in millimetres.

Technical Information

DOUBLE-SIDED STOVES

EXE - Double-Sided, double depth - Solid Fuel

YM-EXE-DDW1	Woodburning, flat top, single door
YM-EXE-DDW2	Woodburning, flat top, double doors
Options	
YM-EXE-DDMFKIT	Multi-fuel kit, static
YM-A9902	Spark guard (suitable for double door Exe only)
4227	Ash Caddy
BL/BR/GR	Coloured paint supplement, add BL (Metallic Blue), BR (Metallic Brown) or GR (Metallic Green) suffix to stove code

DEVON - Double-Sided, single depth - Solid Fuel

YM-DEV-SDW1	Woodburning, flat top, single door
YM-DEV-SDW2	Woodburning, flat top, double doors
YM-DEV-SDWLC1	Woodburning, low canopy, single door
YM-DEV-SDWHC2	Woodburning, high canopy, double doors
Options	
YM-DEV-SDMFKIT	Multi-fuel kit
YM-A9902	Spark guard (suitable for double door Devon only)
4227	Ash Caddy
BL/BR/GR	Coloured paint supplement, add BL (Metallic Blue), BR (Metallic Brown) or GR (Metallic Green) suffix to stove code

DEVON - Double-Sided, double depth - Solid Fuel

YM-DEV-DDWLC1	Woodburning, low canopy, single door
YM-DEV-DDWHC2	Woodburning, high canopy, double doors
Options	
YM-DEV-DDMFKIT	Multi-fuel kit, static
YM-A9902	Spark guard (suitable for double door Devon only)
BL/BR/GR	Coloured paint supplement, add BL (Metallic Blue), BR (Metallic Brown) or GR (Metallic Green) suffix to stove code

COUNTY - Double-sided, single depth - Solid Fuel

YM-COU-SDW2	Woodburning, flat top, double doors
YM-COU-SDWLC2	Woodburning, low canopy, double doors
YM-COU-SDWHC2	Woodburning, high canopy, double doors
Options	
YM-COU-SDMFKIT	Multi-fuel kit, static
BL/BR/GR	Coloured paint supplement, add BL (Metallic Blue), BR (Metallic Brown) or GR (Metallic Green) suffix to stove code

COUNTY - Double-Sided, double depth - Solid Fuel

YM-COU-DDW2	Woodburning, flat top, double doors
YM-COU-DDWLC2	Woodburning, low canopy, double doors
YM-COU-DDWHC2	Woodburning, high canopy, double doors
Options	
BL/BR/GR	Coloured paint supplement, add BL (Metallic Blue), BR (Metallic Brown) or GR (Metallic Green) suffix to stove code

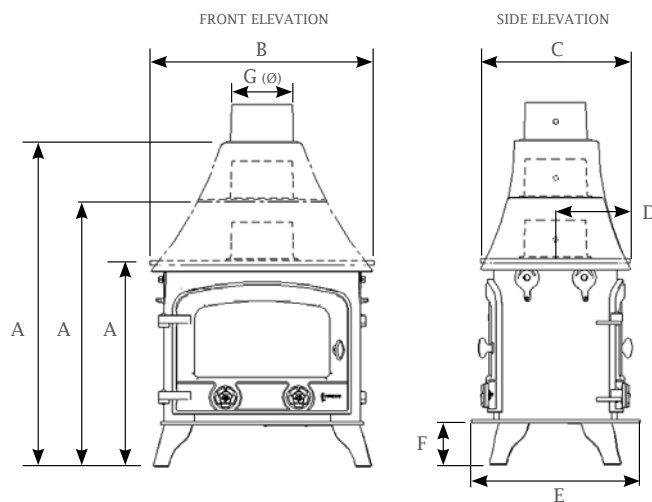

	Depth	Doors	A	B	C	D	E	F	G (∅)
Exe - Flat Top	Double	1 or 2	517	620	545	272.5	580	89	153
Devon - Flat Top	Single	1 or 2	563	615	410	205	462	115	153
Devon - Low Canopy	Single	1	733	604	410	205	462	115	153
Devon - High Canopy	Single	2	888	610	400	200	462	115	153
Devon - Low Canopy	Double	1	731	635	623	311.5	655	115	153
Devon - High Canopy	Double	2	888	642	628	314	655	115	153
County - Flat Top	Single	2	597	758	540	270	590	120	153
County - Low Canopy	Single	2	820	768	587	293.5	590	120	153
County - High Canopy	Single	2	935	768	540	270	590	120	153
County - Flat Top	Double	2	597	796	830	415	875	120	153
County - Low Canopy	Double	2	820	768	822	411	875	120	153
County - High Canopy	Double	2	935	778	820	410	875	120	153

All above dimensions provided in millimetres.

Technical Information

CL WOOD & MULTI-FUEL STOVES

CL3, CL5, CL5 Wide AND CL8 - Woodburning & Multi-fuel stoves

YM-CL3MF1U	CL3, Multi-fuel with universal cast top plate
YM-CL5W1U	CL5, Wood with universal cast top plate
YM-CL5MF1U	CL5, Multi-fuel with universal cast top plate
YM-CL5WIDW1U	CL5, Wide, Wood with universal cast top plate
YM-CL8W1U	CL8, Wood with universal cast top plate
YM-CL8MF1U	CL8, Multi-fuel with universal cast top plate

Options

YM-CL3SCKIT	Smoke Control Kit for CL3 Multi-fuel
YM-CL5SCKIT	Smoke Control Kit for CL5 Woodburning
YM-CL5MF5SCKIT	Smoke Control Kit for CL5 Multi-fuel
YM-CL3-HSK	Heat Shield Kit for CL3
YM-CL5-HSK	Heat Shield Kit for CL5
VW-5WIDHSK	Heat Shield Kit for CL5 Wide
CL-MFKIT5WID	Multi-fuel Kit for CL5 Wide

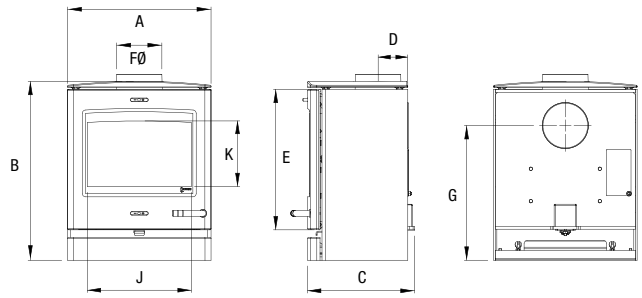

	A	B	C	D	E	F	G	J	K	Weight
CL3	360	532	328	93	416	128	400	240	195	79kg
CL5	435	542	325	90	426	128	408	315	199	81kg(WB) 93kg(MF)
CL5 WIDE	563	572	291	90	478	128	447	441	240	106kg(WB) 124kg(MF)
CL8	563	596	385	105	478	153	449	441	245	105kg(WB) 114kg(MF)

All above dimensions provided in millimetres.

CL5 Midline and Highline - Multi-fuel stoves

YM-CL5MIDMF1T	CL5 Midline, Multi-fuel with top exit cast top plate
YM-CL5MIDMF1R	CL5 Midline, Multi-fuel with rear exit cast top plate
YM-CL5HLMF1T	CL5 Highline, Multi-fuel with top exit cast top plate
YM-CL5HLMF1R	CL5 Highline, Multi-fuel with rear exit cast top plate

Options

YM-CL5MF5SCKIT	Smoke Control Kit for CL5 Multi-fuel
YM-CL5-HSK	Heat Shield Kit for CL5 Midline & Highline

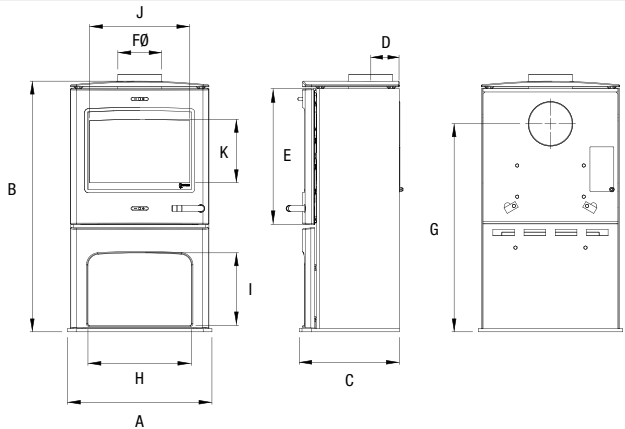

	A	B	C	D	E	F	G	H	I	J	K	Weight
CL5 Midline	454	788	314	90	426	128	654	325	224	315	199	109kg
CL5 Highline	454	898	314	90	426	128	764	325	333	315	199	116kg

All above dimensions provided in millimetres.

CL7 INSET - Multi-fuel fire

YM-CL7NMF1	CL7 Inset, Multi-fuel
------------	-----------------------

Option

YM-CL7SCKIT	Smoke Control Kit for CL7 Inset Multi-fuel
-------------	--

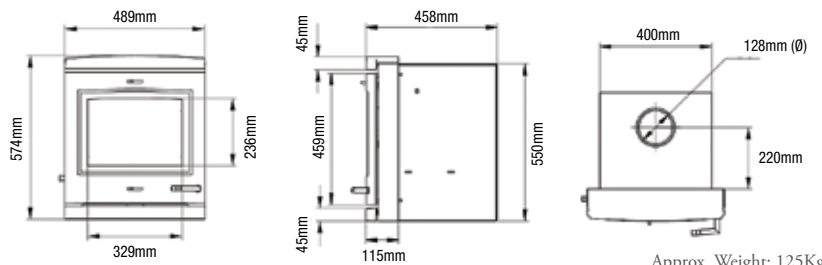

Approx. Weight: 125Kg

CL MILNER INSET - Multi-fuel fire

YM-CLMB1	CL Milner, Multi-fuel
----------	-----------------------

Option

YM-CL7SCKIT	Smoke Control Kit for CL Milner Multi-fuel
-------------	--

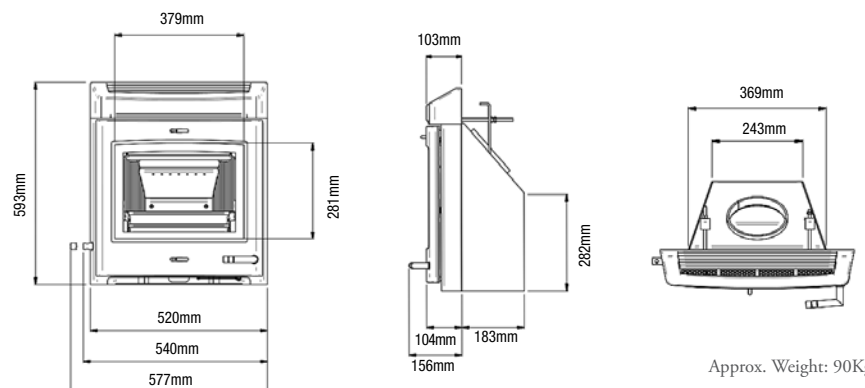

Approx. Weight: 90Kg



CL 670 Inset Gas



Yeoman Gas and Electric Stoves and Fires

Several of the stoves in this brochure are also available as electric or gas versions. Yeoman's highly efficient gas range feature superbly realistic fuel beds and are developed with innovative features such as choice of fire linings and thermostatic remote controls!

Perfect for the hallway, study or conservatory, Yeoman's electric stoves can be simply plugged in and switched on for that 'real fire' look, brought alive with unique VeriFlame™ technology which provides a variable combination of flame speed and glow level. The individually hand-painted 'logs' perfectly mirror the atmosphere and attraction of a real woodburning stove.

Operation is simple too as the stove's remote control not only allows VeriFlame™ selection but also adjustment of the heat combinations. The amount of heat produced can be altered between 1kW and 2kW depending on the warmth required. You can even enjoy the flames without the heat!



For more details, please see the Yeoman Gas & Electric Stoves & Fires brochure or contact your local expert retailer for further information. Alternatively, you can view or download the complete range online by visiting www.yeomanstoves.co.uk.



Dartmoor Gas



All fire & flame photography has been taken from genuine products; however, the exact appearance of the flame picture for any appliance will vary depending on the nature of the flue type, installation surroundings, local geographical features & the way in which the appliance is operated. Please note: The operation & appearance of gas appliances depends on variable factors such as the gas pressure supplied.

Yeoman Stoves gratefully acknowledge the assistance of the following companies with photographic settings:

Furnishings and Ornaments: - **Birlea** - www.birlea.com; **Desenio** - www.desenio.co.uk; **Eclectique** - www.eclectique.co.uk; **Furniture Village** - www.furniturevillage.co.uk;
Fagins Antiques - www.faginsantiques.com; **Laura Ashley** - www.lauraashley.com; **Orange Tree** - www.theorangetree.co.uk; **Debenhams** - www.debenhams.co.uk;
House Of Fraser - www.houseoffraser.co.uk; **The Cook Shop** - www.justaddfood.co.uk; Wood Flooring: - **Beach Bros Ltd** - www.beachbros.co.uk;
Stone Flooring and Wall Tiles: - **Original Style** - www.originalstyle.com; **Walls and Floors** - www.wallsandfloors.co.uk; Stone Mantels: - **Farmington** - www.farmington.co.uk;
Conservatories: - **Apple Conservatories** - www.appleconservatories.com;



CL5 Highline Multi-fuel Stove

Yeoman

A NATURAL WARMTH

Falcon Road, Sowton Industrial Estate, Exeter, Devon EX2 7LF

Solid Fuel Trade Sales

Tel: 01392 474500

Fax: 01392 219932

Gas & Electric Trade Sales

Tel: 01392 261900

Fax: 01392 444148

Other Depts Tel: 01392 474011

e-mail: yeoman@stovax.com

www.yeomanstoves.co.uk



You can find your nearest retailer by visiting
www.yeomanstoves.co.uk/find-a-retailer



Your local Yeoman retailer

£2.00



Paper sourced from sustainable forests and printed using vegetable based inks