

**NOT
AVAILABLE
ONLINE**

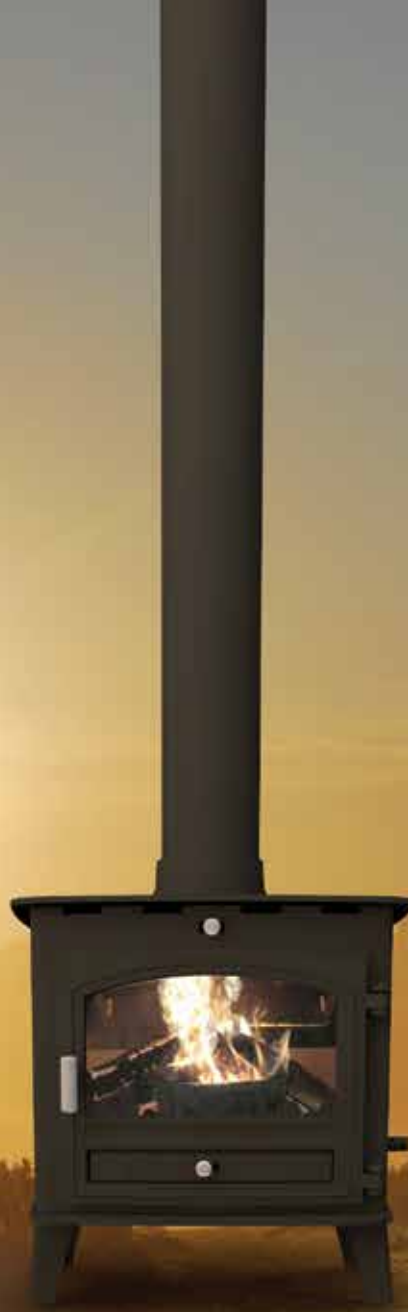

An Englishman's
home is his castle

There's a warm glow
in your window.



Kick off your shoes and
come in... there's a fire
flickering behind the glass.
An Avalon stove will make
your house feel like home.

TAKE A SEAT. WE CHALLENGE YOU not to stretch out your toes and get cosy when you light up an Avalon fire. You needn't get up. These days, a real fire is only half the work.

BUILT WITH ALL THE MOD-CONS, these stylish stoves boast lower emissions, higher fuel economy, and greater performance than ever. You need barely move a muscle to operate the controls, and improved efficiency means you won't have to re-build the fire constantly. So go ahead and get lazy. An Avalon is the next best thing to having your own staff.

Avalon Warranty







AVALON WARRANTY

NEW. You can now buy an extra-long warranty for your stove, boosting it from 2 to 5 years. We ask that your stove is serviced annually – see terms & conditions at www.avalon-stoves.co.uk.



AVALON

Contents

Avalon Compact 5	page 2	
Avalon 4	page 4	
Avalon 5 Slimline	page 6	
Avalon 6	page 8	
Avalon range	page 10	
Cleanburn technology	page 11	
Technical Key	page 12	



The best-looking compact stove in the county? I should say.

The Avalon Compact 5 is outrageously good-looking. But there's more to it than that. The Avalon Compact 5 features Tripleburn technology – three streams of air to provide a super-efficient burn. This is one petite package with a lot to offer. Fit it into the smallest space, and enjoy up to 5.5kW of feet-warming heat. Perfect for country cottages and city lofts. Put on your dressing gown and toast the crumpets!

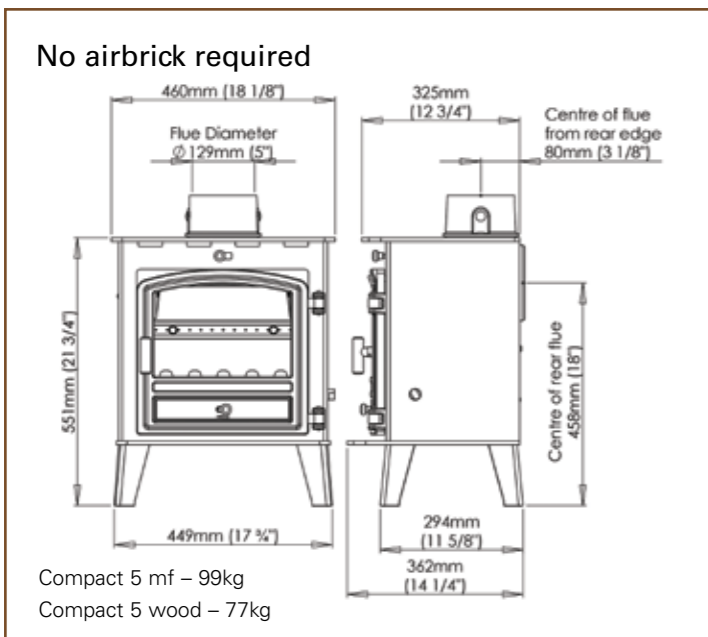

AVALON COMPACT 5



Well groomed and hard-working – you don't see that often.

You'll be surprised by the ingenious workings of this cunning contraption. Avalon 4 has loads of charisma – and the performance of a Rolls. It belts out up to 6kW and uses less fuel than old models. A hot airwash means you needn't trouble the butler to clean it as often, and cool-touch handle enables easy operation. You have a choice of wood or solid fuel, allowing you to optimise your heating system (and fuel bills). Jolly clever stuff, eh?

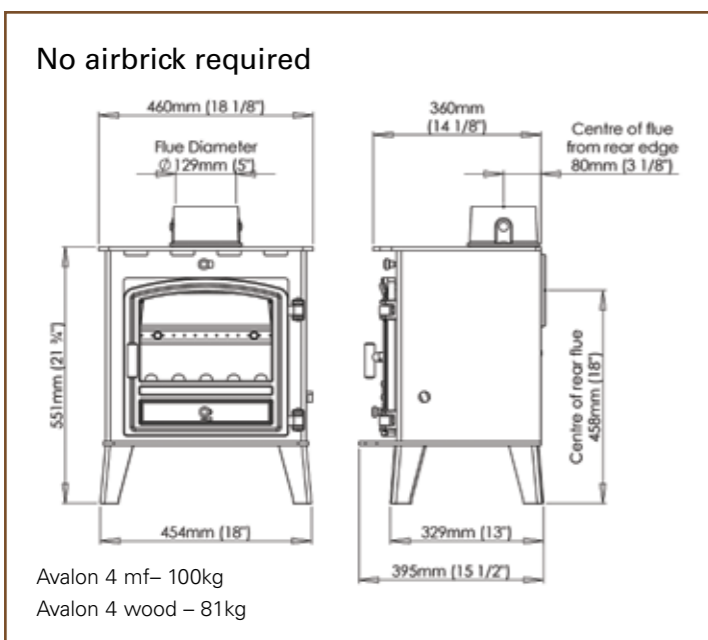

AVALON 4



Enjoy a little bit of the high life.

The sumptuously slender Avalon Slimline 5 has the styling and performance – all in a slim wide body. Simply perfect for hearths where space is tight. The space saving fuel bed retains the efficiency and output of a more voluptuous model and a widescreen door accomodates the view to an ample 16” log fuel load. It’s got all the mod-cons to boot. So now you can have grand, English country-house style – in a smaller space.

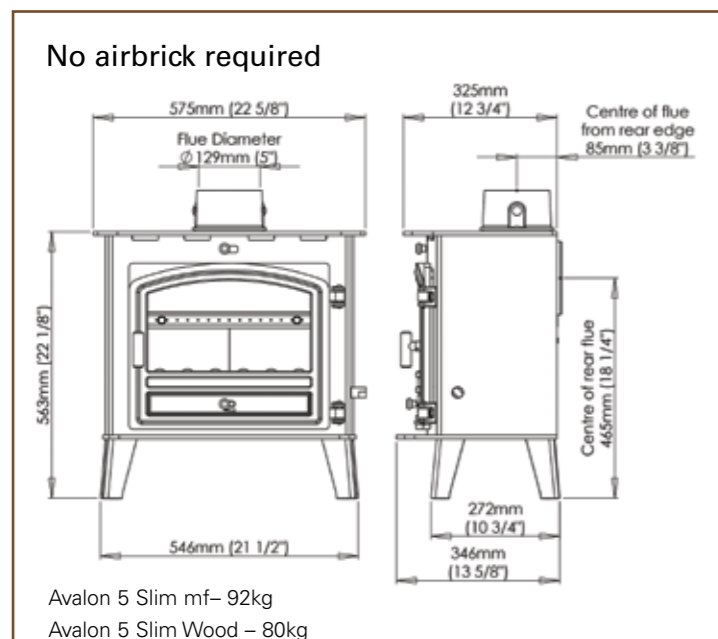

AVALON SLIMLINE 5

Tested at over
78% Efficiency

**DEFRA
APPROVED**



There are moments in life when everything goes right.

And you can enjoy plenty of those moments beside this delightfully informal fire (as long as you don't have guests). It's a roaring, family-sized fire – with a contemporary look and all-new technology. Providing up to 6.5kW (nominal output 5.5kW), with lower-than-ever emissions, this is a stove that's as kind to the environment as it is to your cold tootsies. Gather the family (or banish them from the room) and get comfy!

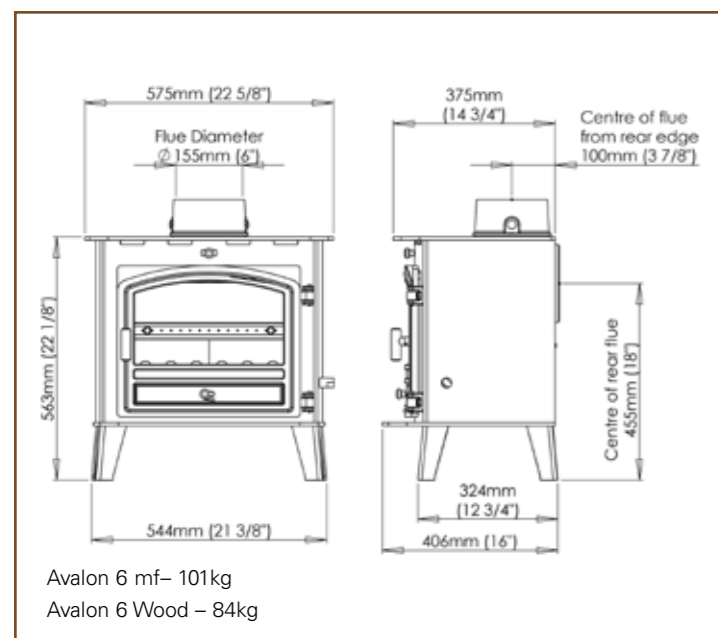

Heat Output 4kW - 7.5kW



AVALON 6



Avalon Range

Independently CE Tested and Approved
Specified stoves in the Avalon Range have been independently certified meeting the stringent CE requirement.

New Avalon Cleanburn Technology
Cleanburn technology means that more of the fuel is ignited, resulting in an increased heat output, less smoke, and a cleaner environment.

Exceptionally Efficient
Currents of air inside the stove ensure that fuel is burnt evenly and efficiently.

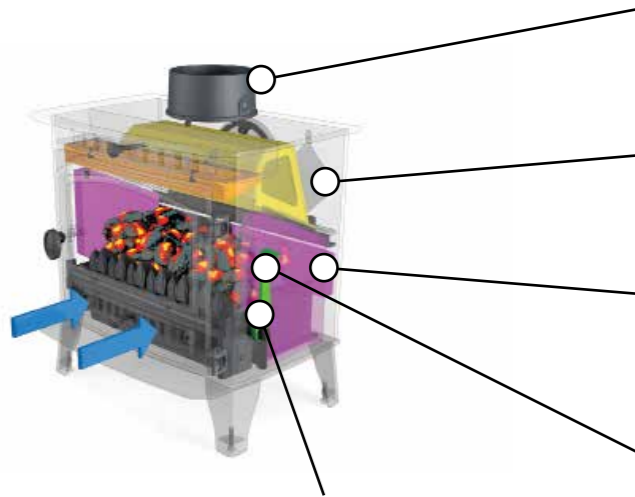

Safe and Efficient for Over-Night Burning
By reducing the air inflow to an absolute minimum, you can keep the fire gently smouldering overnight. Come morning, increase the air flow and the fire will return to life.

Dust Free, Safe and Easy Riddling
The riddling tool enables you to clean the grate without causing clouds of dust. Just move it back and forth with the doors closed.

Interchangeable Flue Outlets
Free standing stoves in the Living Design Range can be flued from either the top or the rear of the stove.

Easy Access for Chimney Sweeping
Every stove features a removable throat-plate, giving full and easy access for sweeping the chimney.

Internal Lining System
The new internal lining system maximises the firebox temperature, ensuring complete combustion.

Cold-handled Riddling Tool
The cold-handled riddling tool can be used for opening and closing the doors, riddling the grate, grate adjustment and easy removal of the ash-pan.

From Wood to Multi-Fuel with a Single Movement of the Tool

The stove's integral grate can be changed from wood to multi-fuel setting with a single movement of the cold-handled riddling tool.

All the Avalon stoves are manufactured from high quality 5mm thick steel and have cast iron components. They feature the new Cleanburn Technology, they all burn wood, smokeless fuels and peat on a dust-free de-ashing system, and have a hot airwash system keeping the glass clean to see through.

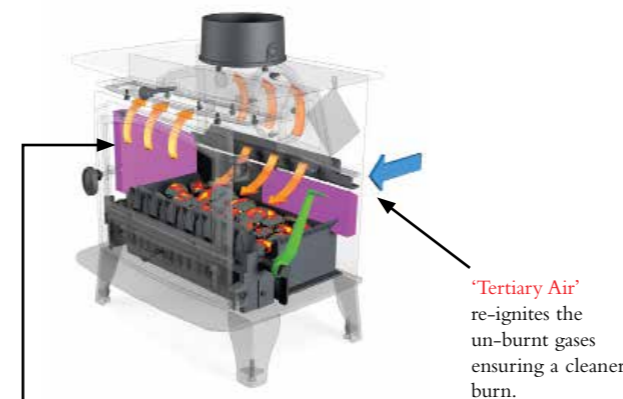

'Tertiary Air'
re-ignites the un-burnt gases ensuring a cleaner burn.

The New Avalon **'Internal Lining System'** maximises the firebox temperature, ensuring complete combustion.

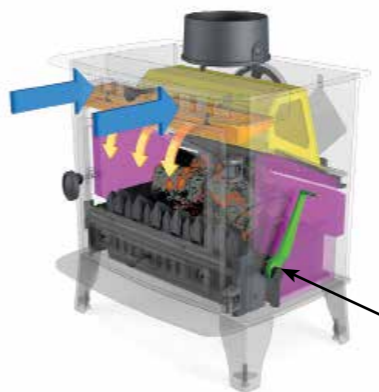
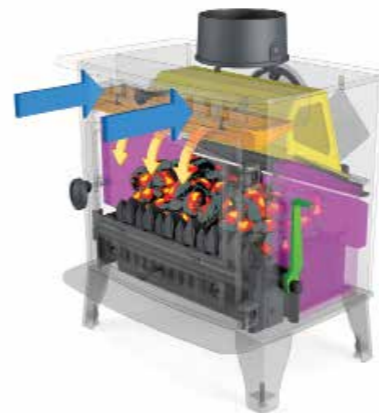

Grate in 'back' closed position for burning wood

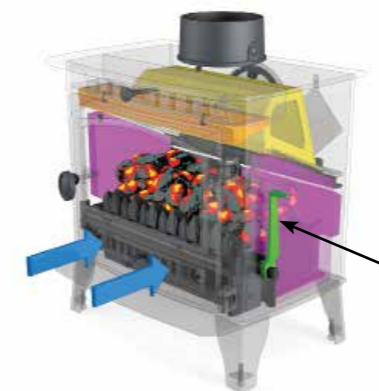

Grate in 'forward' open position for burning solid fuel



CLEANBURN, our innovative technology is not only better for the stoves, it's also better for the environment.

The idea behind Cleanburn is to maximise combustion, so that more fuel is burnt and less is turned into deposits in the stove, chimney, or atmosphere.

Our Cleanburn stoves have been proven to have lower emissions, which makes them among the most eco-friendly models on the market.

No need to scrub the glass door

Our innovative airwash draws air from the top of the stove, heats it up in the central air chamber and then sends it down behind the glass door, creating a screen between the fire and the glass. Smoke or combustion particles do not come into contact with the glass, so you don't need to clean it.

Optimum Woodburning Conditions

Three streams of hot air ensure that fuel is burned efficiently by maximising combustion. For wood, close the grate and allow a deep bed of ash to build up - the optimum conditions for combustion.

Optimum Smokeless Fuel Burning Conditions

When you're burning smokeless fuel, just switch the grate to the open position. Air flows beneath the grate and into the heart of the fire - the optimum conditions for burning solid fuel.



Avalon Technical Key

	Avalon 4	Avalon Compact 5	Avalon Slimline 5	Avalon 6
Heat Output Range	3.5 - 6kW	3 - 5.5kW	3.5 - 6kW	4 - 7.5kW
Efficiency on wood %	78	76	74.1	75.9
Flat Top	✓	✓	✓	✓
Single door	✓	✓	✓	✓
Multi Fuel Option (Riddling Grate)	✓	✓	✓	✓
Stainless Steel knob set	✓	✓	✓	✓
Flue Damper	•	•	•	•
Hot Airwash Technology	✓	✓	✓	✓
Cleanburn Technology	✓	✓	✓	✓
CE Approved	✓	✓	✓	✓
Flue Gather Box	•	•	•	•
Ventilation (mm ²)	*	*	*	825
Log length (approx)	11" - 280mm	13" - 330mm	16" - 400mm	15" - 380mm

✓ = standard ~ = not available
 • = option * = no airbrick required



Options



Optional flue gather box, for rear flue installations and limited space installations



Optional flue damper





Your Avalon dealer