

**THERMOROSSI**

*Fire Lovers*

*- Wood Home Collection -*





*Fire Lovers*  
**THERMOROSI**

*- Wood Home Collection -*



Since 1968



# To present

- ITA Sorta in una provincia ricca di tradizione metalmeccanica e aperta alle più innovative tecnologie, Thermorossi opera con successo da oltre 45 anni nel settore dei riscaldamento fino a diventare, oggi, una tra le più affermate ed avanzate industrie europee nella produzione di stufe, termocucine e caldaie.
- DEU Seit 45 Jahren arbeitet Thermorossi in der Heizungsbranche mit Erfolg und zählt heute als einer der namhaftesten und innovativsten Hersteller von Kaminoefen, Zentralheizungskoch-herden und Heizkesseln in Europa.
- ENG Established in a province renowned for its metalworking traditions and open to modern technology, Thermorossi has been working with success in the heating sector for 45 years and is now one of the leading and advanced European companies in the production of stoves, central heating cookers and boilers.
- FRA Installé depuis plus de 45 ans dans une région riche en tradition mécanique et métallurgique ouverte aux technologies les plus avancées, Thermorossi est un des leaders européens dans la production de poêles, inserts, thermo-cuisinières et chaudières, à bûches et à granulés.
- ESP Establecida en una provincia renombrada por su tradición metalúrgica y abierta a las tecnologías más modernas, Thermorossi trabaja con éxito en el sector de la calefacción desde hace 45 años y ahora es una de las empresas europeas principales y más avanzadas en la producción de estufas, cocinas de calefacción central y calderas de leña.





Il fascio tubiero verticale e l'elevato numero di elementi formano il sistema Thermocore®. Il sistema incrementa la superficie di scambio e migliora il rendimento termico

Der vertikale Rohrwärmetauscher mit großer Wärmetauscherfläche ist das Herzstück des Thermocore® Systems. Dieses System steigert die Wärmetauscherfläche und erhöht den Wirkungsgrad

The vertical pipes heat exchanger and the high number of exchange elements form the Thermocore® system. This system increases the exchange surface and improve thermal efficiency

Le faisceau tubulaire vertical et ses nombreux éléments forment le système Thermocore®, qui augmente la superficie d'échange de chaleur et améliore le rendement thermique

El intercambiador turbolador vertical de muchos elementos crea el sistema Thermocore®. Este sistema aumenta la superficie de intercambio y mejora el rendimiento térmico



Rigidi criteri costruttivi, elevati spessori della materia prima impiegata, offrono un grande accumulo termico e durata dei componenti

Hohe Produktionsstandards, hohe Qualität der Rohstoffe, garantieren lange Lebensdauer aller feuerberührten Teile und des Brenners

The strict manufacturing standards, the high quality of raw materials, grant higher heat accumulation, stable durability of the burning pot and other components

Les critères de construction rigides, les grosses épaisseurs des matériaux utilisés, offrent une grande capacité d'accumulation thermique, de stabilité dimensionnelle du brûleur, et de durée des composants

Nuestros equipos son el resultado de exigentes criterios de construcción. Ofrecemos equipos con una gran acumulación térmica, estabilidad dimensional del quemador y durabilidad de los componentes



Il grande cassetto cenere e le adeguate ispezioni per la pulizia semplificano la manutenzione mantenendo l'efficienza ai massimi livelli

Der große Ascheauffang sowie die leicht zugänglichen Reinigungsöffnungen machen die Reinigung des Gerätes viel einfacher und komfortabler, wodurch die Effizienz des Gerätes hoch gehalten wird

The wide ash pan and the obvious inspection points make maintenance easier keeping the efficiency at highest levels. Simple periodic maintenance

Le grand tiroir des cendres et les inspections de nettoyage pratiques simplifient l'entretien, gardant le rendement au plus haut niveau. Aucune surprise durant l'entretien périodique

El ancho cajón de ceniza y una inspección de limpieza cómoda simplifican la mantención manteniendo el rendimiento a máximos niveles y evitando sorpresas



Smoke by-pass riduce drasticamente l'uscita di fumo nell'ambiente ad ogni carica di legna

Smoke by-pass reduziert Raucheintritts in Wohnbereich mit jedem Holzladung.

Smoke by-pass technology reduces smoke entering the living zone with every wood load.

Le Smoke by-pass réduit les émissions de fumée dans la pièce lors des recharges de bûches.

Smoke by-pass reduce extremamente la salida de humos en la habitación a cada carga de combustible.



Pratico e igienico piano scalda vivande di facile pulizia

Hygienische, simpel zu reinigen, speiseaufwärmende Platte zum kochen ist vorhanden

Incorporates practicality and hygiene, easy to clean hotplate heats food

Chauffe-plats pratique et hygiénique, simple à nettoyer

Práctico plano para calentar comidas higiénico y fácil de limpiar



La camera di combustione è completamente rivestita da materiale refrattario ceramico HEATSTONE® resistente alle alte temperature.

Feuerraum aus HEATSTONE® feuerbeständig Keramik Material.

Combustion area is covered by the HEATSTONE® fire-resistant ceramic material.

La chambre de combustion est entièrement revêtue de matériel réfractaire-céramique HEATSTONE® résistant aux hautes températures.

El hogar es completamente revestido con material refractario cerámico HEATSTONE® resistente a altas temperaturas.



Tecnologia TimeXtend®: accumulo inerziale progettato per recuperare e trattenere il calore sprigionato dai gas di combustione.

TimeXtend® Technologie: thermisch Trägheitsakkumulation konstruiert für verhalten und wiedererlangen die Verbrennungswärme.

TimeXtend® technology: thermic inertial accumulation designed to recover and retain the combustion heat.

Technologie TimeXtend® : accumulateur thermique à inertie projeté pour récupérer et conserver la chaleur dégagée par les gaz de combustion.

Tecnología Timextend®: acúmulo de inercia diseñado para mantener el calor producido por los gases de combustión.



Forno smaltato completo di griglia e leccarda.

Backofen emailiert mit Grill und Fettpfanne.

Enamelled oven complete with grill and dripping pan.

Gour émailé avec grill et lèche-frite.

Horno esmaltado con parrilla y bandeja de grasas.



Corpo caldaia garantito 8 anni contro la corrosione dovuta ai fumi acidi della combustione.

Garantie: 8 Jahre gegen Korrosion durch korrosive Dämpfe bei der Verbrennung.

8 years guarantee against corrosion caused by acid combustion Smoke.

Garanti 8 années contre la corrosion par les fumées acides de la combustion.

Garantía 8 años contra la corrosión de los humos ácidos de la combustión.



Input esterno dell'aria primaria

Eintritt der primäre Luft vom außen

External primary air input

Entrée d'air primaire externe

Entrada externa de aire primario



Made in Italy: Thermorossi si avvale delle più moderne tecniche di produzione e tutti i prodotti sono conformi alle più severe normative europee

Made in Italy: Thermorossi benutzt die neuesten Fertigungsmethoden und alle Geräte erfüllen die strengsten Anforderungen der Europäischen Richtlinien bezüglich Sicherheit und Umweltschutz

Made in Italy: Thermorossi uses the most modern techniques of production and all products conform to the strictest European regulations.

Made in Italy: Thermorossi se sert des techniques de production les plus performantes et tous les produits sont conformes aux normes européennes les plus sévères

Made in Italy: Thermorossi utiliza las técnicas más modernas de producción y todos los productos se ajustan a las más estrictas normas europeas



Capace di distribuire il calore in più ambienti e riscaldare più locali anche su piani diversi

Kann Wärme auf mehrere Räume verteilen und mehrere Räumlichkeiten auf verschiedenen Stockwerken beheizen

Capable of distributing heat to various rooms, even on different floors

Capable de distribuer la chaleur dans plusieurs pièces et de chauffer plusieurs locaux, même sur différents étages

Capaz de distribuir el calor en varias habitaciones y calentar varios locales, aunque estén en pisos diferentes



Telecomando in dotazione

Fernbedienung im Lieferumfang enthalten

Remote control included

Doté de télécommande de série

Mando a distancia incluido



Il ventilatore ambiente, con rotore esterno, è garantito 4 anni perché ermetico alla polvere

4 Jahre Garantie auf den hermetisch dichten Raumluftventilator

External rotor room fan is guaranteed for 4 years being hermetic to dust

Le ventilateur d'air ambiant, avec son moteur à rotor externe, est garanti 4 ans parce qu'hermétique à la poussière

El ventilador ambiente con motor rotor externo lleva 4 años de garantía al ser ermetico al polvo



I nostri prodotti a regime minimo misurano solo 36 decibel di fruscio durante il funzionamento

Unsere Produkte emittieren nur 36 Dezibel bei kleinster Heizleistung

Our products produce only 36 decibels of noise at minimum level of operation

Au régime minimum de fonctionnement, nos produits émettent seulement 36 décibels de bruit

Nuestros equipos trabajan a niveles mínimos de sonido. Solamente miden 36 decibelios de sonoridad a nivel mínimo de operación



Sistema di filtraggio della polvere facilmente ispezionabile e lavabile

Raumluftfilter; Der Filter ist einfach zu reinigen

Warm air filtering system; the filter is easy to check and clean

Système de filtrage de l'air chaud : le filtre s'inspecte et se lave facilement

Sistema de filtración del aire de calefacción con filtro que se puede inspeccionar y lavar fácilmente



Selezioniamo i migliori componenti per garantire un basso consumo energetico

Wir verwenden nur die besten Komponenten für den geringsten Stromverbrauch

We select only the best components to minimize energy consumption

Nous sélectionnons les meilleurs composants pour garantir les consommations énergétiques les plus basses

Seleccionamos sólo los mejores componentes para garantizar el ahorro energético

ALL PLUS IN ONE WITH:



AIRBOX (optional) è il gruppo di ventilazione termostata con portata a bocca libera di 390 m³. Grazie a questo accessorio la stufa diventa ventilata e canalizzabile.

AIRBOX (optional) ist eine Belüftungsgruppe, die über ein Thermostat funktioniert, und eine freie Förderleistung von 390 m³ hat. Dank dieses Zubehörs wird der Ofen belüftet und kanalisierbar.

AIRBOX (optional) is the thermostat-controlled ventilation unit with an unobstructed air supply duct capacity of 390 m³. The simple application of this accessory to the heater adds two extra features – a ventilation and a hot air channelling system.

AIRBOX (optional) est le groupe de ventilation thermostaté avec débit à sortie libre de 390 m³. Grâce à cet accessoire le poêle devient ventilé et canalisable.

AIRBOX (optional) es el grupo de ventilación equipado con termostatos con caudal con boca libre de 390 m³. Gracias a este accesorio la estufa está ventilada y es posible canalizarla.

Dispositivi per la regolazione dell'aria primaria, secondaria e terziaria  
Primary, secondary and tertiary air modulation devices

Scambiatore di calore brevettato con tecnologia Thermocore®  
Thermocore® pipe heat exchanger

Smoke by-pass, riduce drasticamente l'uscita di fumo nell'ambiente ad ogni carica di legna  
Smoke by-pass technology reduces the smoke outlet to the living zone before every wood load

Camera di combustione in HEATSTONE®, ottimizza la combustione e riflette il calore nell'ambiente  
Burning room covered by the HEATSTONE®, it optimizes the fuel and reflects the heat to the environment

AIRBOX (optional): riscalda più ambienti, la stufa diventa ventilata e canalizzabile, radiocomando in dotazione.

AIRBOX (optional): it heats several rooms, the stove becomes vented and air-ducting, remote control inclusive as standard

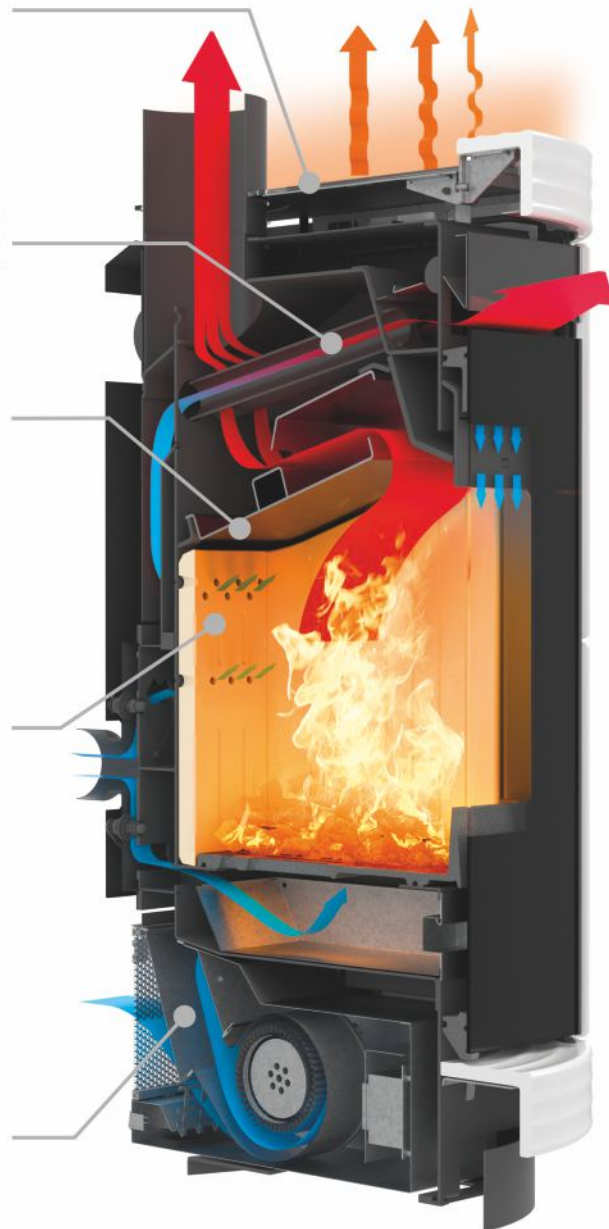

«L'efficienza fino al 91% permette di ridurre il consumo di legna fino al 20% rispetto ad una stufa convenzionale»

«The efficiency of up to 91% reduces the wood consumption of up to 20% compared to a conventional stove»

## tecnologia «WOOD»

ITA Per ottimizzare il consumo di legna ed incrementare la resa termica le nostre stufe hanno una grande superficie di scambio e lunghi percorsi obbligati per i fumi. Il giusto rapporto in camera di combustione di aria primaria e secondaria garantisce una doppia combustione con maggiore autonomia, consumi ridotti e minore emissione di CO in atmosfera. L'ossigeno viene controllato su tre zone indipendenti con due leve appositamente studiate.

DEU Um den Holzverbrauch zu optimieren und um die Wärmeleistung zu erhöhen, haben unsere Öfen eine große Austauschfläche und lange vorgeschriebene Rauchwege. Das richtige Verhältnis in der Brennkammer von Primär- und Sekundärluft garantiert eine doppelte Verbrennung mit größerer Autonomie, einen eingeschränkten Verbrauch und eine geringere CO-Emission in die Atmosphäre. Der Sauerstoff wird kontrolliert auf drei unabhängigen Zone mit zwei extra dafür durchdachten Hebeln kontrolliert.

ENG To optimise fuel consumption and increase thermal performance our heaters feature large heat exchange surfaces and long forced smoke outlets. The correct ratio of primary to secondary air in the firebox guarantees a double combustion with increased autonomy, reduced consumption and lower CO emission levels. The oxygen is controlled in two independent areas with three specially-designed levers.

FRA Pour optimiser la consommation de bois et augmenter le rendement thermique, nos poêles présentent une grande surface d'échange et des longs parcours obligés pour les fumées. Le juste rapport entre l'air primaire et secondaire dans la chambre de combustion garantit une double combustion avec une plus grande autonomie, une consommation réduite et moins d'émissions de CO dans l'atmosphère. L'oxygène est contrôlé en deux zone indépendantes avec trois leviers spécialement conçus à cet effet.

ESP Para optimizar el consumo de leña e incrementar el rendimiento térmico, nuestras estufas disponen de una gran superficie de intercambio y largos recorridos obligados para los humos. La justa relación en la cámara de combustión de aire primario y secundario garantiza una doble combustión, con mayor autonomía, consumos reducidos y menor emisión de CO a la atmósfera. Se controla el oxígeno en tres zonas independientes a través de dos palancas expresamente diseñadas.



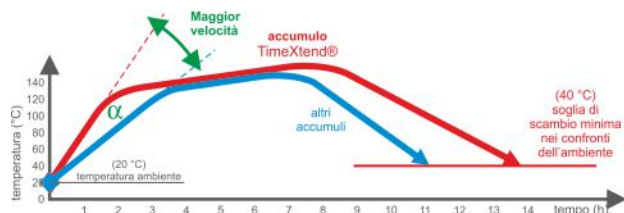

# TIMEXTEND®

**ITA** **Tecnologia TimeXtend®:** accumulo inerziale progettato per recuperare e trattenere il calore sprigionato dai gas di combustione. Il passaggio dei gas attraverso i 4 canali determina una cessione del calore doppia rispetto ad altre realizzazioni costruite da un unico passaggio. Grazie alla sua massa termica il calore viene trattenuto durante il processo di combustione, successivamente rilasciato in modo graduale nell'arco di diverse ore anche a fuoco spento.

**DEU** **TimeXtend® Technologie:** Konstruiert mit Wärmespeichersteinen um die Energie der Abgase thermisch nutzbar zu machen. Durch die 4 Kanäle durch die Speicherblock wird die benötigte Aufheizzeit der Speichermasse um 50% gegenüber einem einzigen Kanal durch die Speicherblock reduziert. Selbst viele Stunden nachdem das Feuer erloschen ist, gibt dieser Speicherblock noch Wärme in den Aufstellraum ab.

**ENG** **TimeXtend® technology:** thermic inertial accumulation designed to recover and retain the combustion heat. The transition of hot smokes through the 4 channels performs a thermic exchange which is double more than other one-channel solutions. Thanks to its thermic block, the heat is held back during the combustion phase, afterwards gradually released over several hours, also after the fire is extinguished.

**FRA** **Technologie TimeXtend® :** accumulateur thermique à inertie projeté pour récupérer et conserver la chaleur dégagée par les gaz de combustion. Le passage des gaz à travers ces 4 canaux détermine une cession de chaleur deux fois plus importante que dans les solutions à un passage unique. Grâce à sa masse thermique, la chaleur est accumulée pendant la phase de combustion, et successivement cédée graduellement pendant plusieurs heures, bien après l'extinction du feu.

**ESP** **Tecnología Timextend®:** acúmulo de inercia diseñado para mantener el calor producido por los gases de combustión. La salida de humos a través de los 4 canales garantiza un intercambio de calor doble respecto a intercambiadores con 1 canal único. Gracias a su masa térmica acumula el calor producido durante la fase de combustión y sucesivamente lo propaga para varias horas después que el fuego se ha apagado.



Dispositivi per la regolazione dell'aria primaria, secondaria e terziaria  
Primary, secondary and tertiary air modulation devices

TimeXtend®, massa termica che si riscalda grazie ai suoi esclusivi 4 canali. Il calore viene trattenuto e rilasciato in modo graduale nell'arco di diverse ore anche a fuoco spento  
TimeXtend® technology: thermic inertial accumulation thanks to the exclusive 4 channels. The heat is recovered and gradually released towards several hours, also after the fire is extinguished

Smoke by-pass, riduce drasticamente l'uscita di fumo nell'ambiente ad ogni carica di legna  
Smoke by-pass technology reduces the smoke outlet to the living zone before every wood load

Camera di combustione in HEATSTONE®, ottimizza la combustione e riflette il calore nell'ambiente  
Burning room covered by the HEATSTONE®, it optimizes the fuel and reflects the heat to the environment

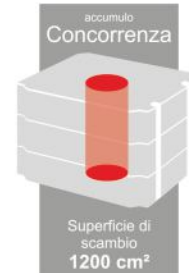



**16m x 1**  
**8m x 2**  
**6m x 3**  
**4m x 4**

16 metri di canalizzazione utilizzando 1 uscita  
16 meters of ducting using 1 outlet  
8 metri di canalizzazione utilizzando 2 uscite  
8 meters of ducting using 2 outlets  
6 metri di canalizzazione usando 3 uscite  
6 meters of ducting using 3 outlets  
4 metri di canalizzazione usando 4 uscite  
4 meters of ducting using 4 outlets



**15m x 1**  
**5m x 2**

15 metri di canalizzazione usando 1 uscita  
15 meters of ducting using 1 outlet  
5 metri di canalizzazione usando 2 uscite  
5 meters of ducting using 2 outlets



**8m x 1**  
**4m x 2**

8 metri di canalizzazione usando 1 uscita  
8 meters of ducting using 1 outlet  
4 metri di canalizzazione usando 2 uscite  
4 meters of ducting using 2 outlets

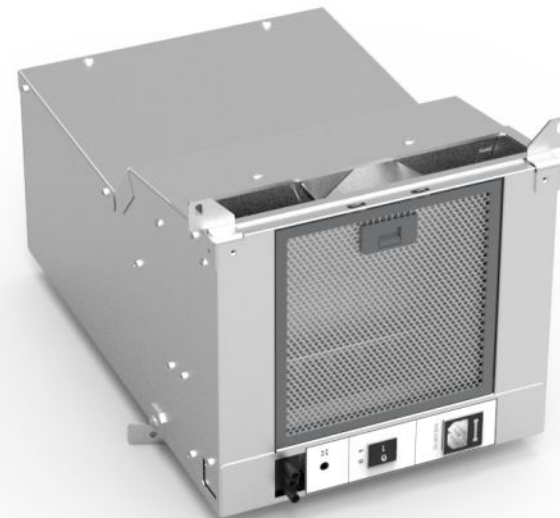

# AIRBOX<sup>®</sup> - gruppo ventilazione

ITA AIRBOX (optional) è il gruppo di ventilazione termostato con portata a bocca libera di 390 m<sup>3</sup>. Grazie a questo accessorio la stufa diventa ventilata e canalizzabile. La quantità dell'aria calda viene regolata dal radiocomando con 4 velocità indicate da segnalatore acustico. Il filtro applicato all'esterno del ventilatore ambiente assorbe notevolmente le polveri presenti nell'aria.

DEU AIRBOX (optional) ist eine Belüftungsgruppe, die über ein Thermostat funktioniert, und eine freie Förderleistung von 390 m<sup>3</sup> hat. Dank dieses Zubehörs wird der Ofen belüftet und kanalisierbar. Die Menge der Warmluft wird durch die Fernsteuerung mit 4 Geschwindigkeiten, die von dem akustischen Signal angegeben werden, reguliert. Der Filter, der außerhalb des Raumheizventilators angebracht ist, absorbiert den in der Luft vorhandenen Staub.

ENG AIRBOX (optional) is the thermostat-controlled ventilation unit with an unobstructed air supply duct capacity of 390 m<sup>3</sup>. The simple application of this accessory to the heater adds two extra features – a ventilation and a hot air channelling system. The hot air quantity is regulated from the radiocontrol with 4 speeds signalled by an acoustic indicator. The filter applied externally to the room fan absorbs a considerable amount of the air-borne dust.

FRA AIRBOX (optional) est le groupe de ventilation thermostaté avec débit à sortie libre de 390 m<sup>3</sup>. Grâce à cet accessoire le poêle devient ventilé et canalisable. La quantité d'air chaud est réglée à travers la télécommande avec 4 vitesses signalées par un indicateur sonore. Le filtre appliqué à l'extérieur du ventilateur d'ambiance absorbe remarquablement les poussières présentes dans l'air.

ESP AIRBOX (optional) es el grupo de ventilación equipado con termostatos con caudal con boca libre de 390 m<sup>3</sup>. Gracias a este accesorio la estufa está ventilada y es posible canalizarla. Un control remoto con 4 velocidades indicadas mediante señalización acústica, regula la cantidad de aire caliente. El filtro situado en la parte exterior del ventilador ambiente absorbe muy bien los polvos presentes en el aire.



# la VETRIFICAZIONE

- ITA Bruciare legna significa creare condensa e fumi acidi che nel tempo possono corrodere il corpo caldaia. Thermorossi da sempre protegge il corpo caldaia con la vetrificazione (optional): il corpo caldaia viene sabbiato diventando poroso, successivamente viene pulito con soffiatura ed immerso in vasche contenenti smalto vetroso liquido che va ad aggrapparsi su tutta la superficie. L'affidabilità di questo trattamento, secondo dati statistici aziendali, è così apprezzabile che Thermorossi garantisce i propri corpi caldaia per 8 anni.
- DEU **Verglasung** - Holzverbrennung bedeutet unter anderem, dass im Laufe der Zeit, durch die korrosiven Gase der Kesselkörper rostet. Thermorossi unterzieht die Kesselkörper seit jeher einer Spezial- Oberflächenbehandlung (optional), wobei der Kesselkörper an der Oberfläche sandgestrahlt, anschließend gereinigt und getrocknet wird. Nachfolgend wird der aufgeraute Kesselkörper in eine Wasser-Glasstaub-Emulsion getaucht, wobei sich diese Lösung völlig auf der gesamten Oberfläche anheftet und speziell in die aufgeraute Oberfläche eindringt. Nach jahrelanger Erfahrung mit diesem speziellen Oberflächenschutz, kann Thermorossi 8 Jahre Garantie auf den Kesselkörper geben, auch deshalb weil die diesbezüglichen Statistiken dies ohne Vorbehalt erlauben.
- ENG **Vitrification** - Wood burning creates condensation and acid smoke that over time can corrode the boiler body. Thermorossi has always protected its boiler body with "vitrification" (optional): the body of the boiler is sandblasted, becomes porous, then it is cleaned by blowing air and finally immersed in big tubs containing liquid vitreous enamel that adhere to the whole surface. According to our statistics this treatment is so reliable that Thermorossi guarantees its boiler bodies for 8 years.
- FRA **Vitrification** - Brûler du bois signifie créer de condensation et de fumées acides, qu'ils peuvent détériorer avec du temps le corps de la chaudière. Thermorossi toujours protège le corps de la chaudière avec la vitrification (optionnel): Le corps de chaudière est sablé et il devient poreux, et ensuite nettoyé par soufflage et après immergé dans des cuves contenant de l'émail liquide et vitreux qui va à s'accrocher sur toute la surface. La fiabilité de ce traitement, selon des données de la Maison, est appréciable au point que Thermorossi garantit les corps vitrifiés 8 ans.
- ESP **Vitrificación** - Quemar leña significa crear condensación y humos acidos que con el tiempo pueden corroer el cuerpo caldera. Thermorossi de siempre protege su cuerpos caldera con la vitrificación (optional): el cuerpo caldera es limpiado con sopladura de arenilla hasta que llegue a ser poroso, es limpiado por aire soplado y sumergido en tanques llenos de esmalte liquido vidrioso que se va a aferrar a toda la superficie. La fiabilidad de este tratamiento, segundo los datos estadísticos, es tan cierta que THERMOROSSI garantiza su cuerpos caldera por 8 años.



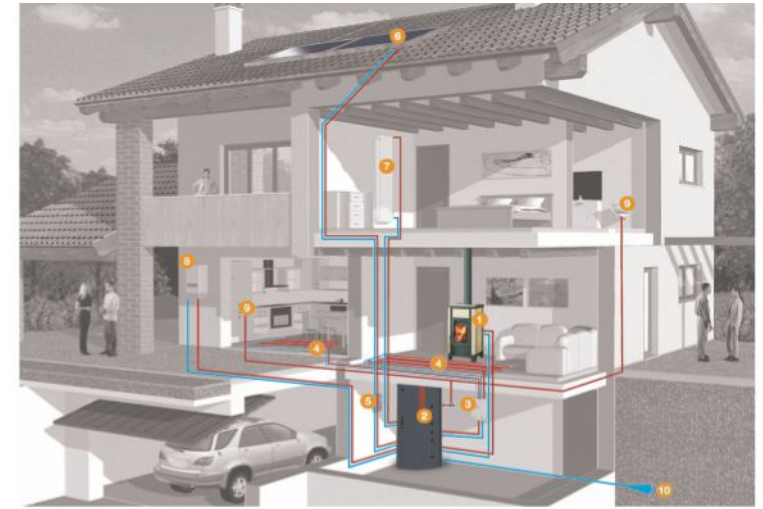
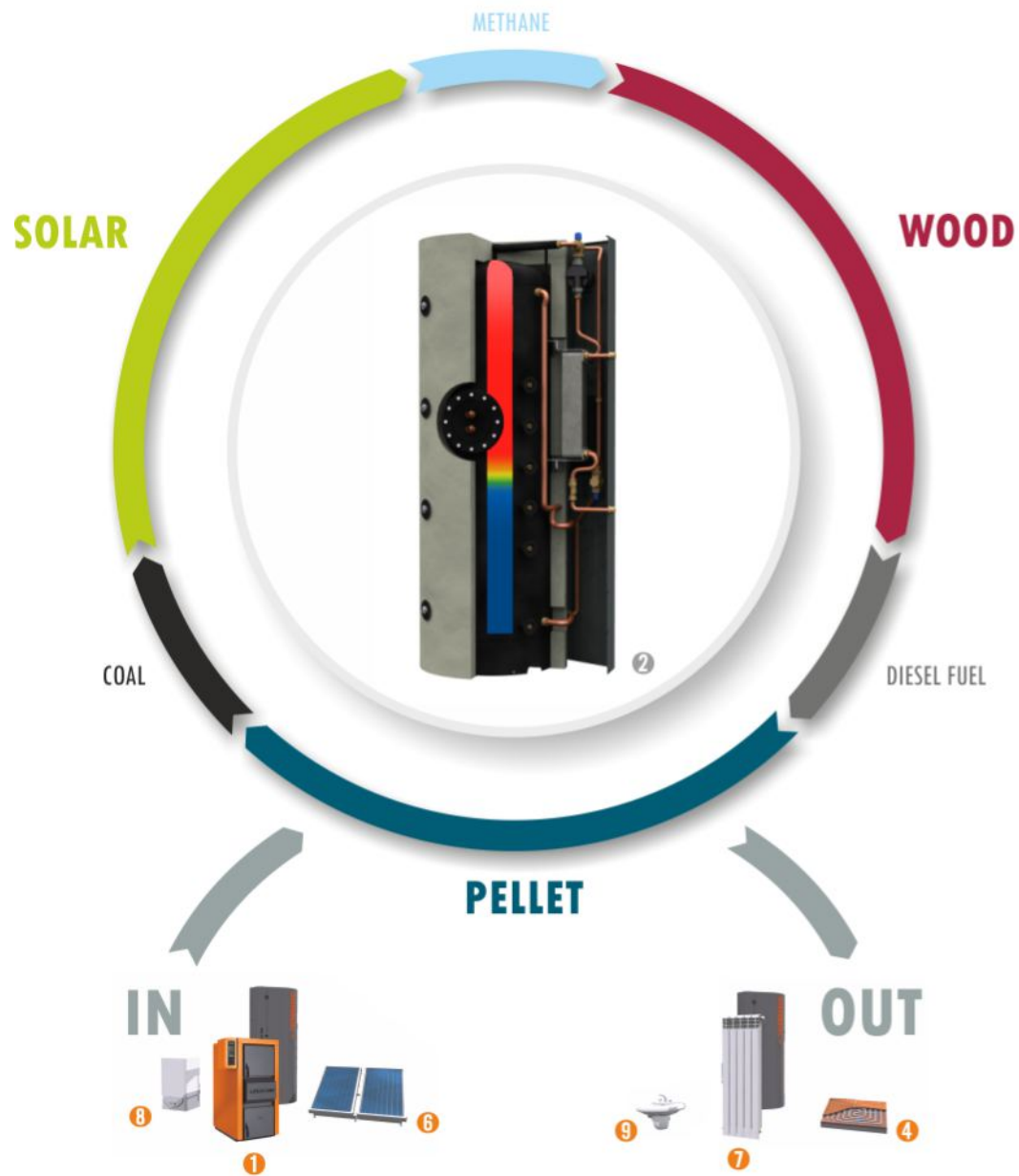

# THERMOCELL®

- ITA** ① Generatore di calore a biomassa. ② Thermocell 250/400/500, accumuli a stratificazione. ③ Gruppo miscelazione impianto. ④ Riscaldamento a pavimento. ⑤ Gruppo miscelazione per pannelli solari. ⑥ Collettore solare. ⑦ Radiatore. ⑧ Caldaia a gas. ⑨ Acqua calda sanitaria. ⑩ Acquedotto.
- DEU** ① Waermeerzeuger. ② Thermocell 250/400/500, Geschichtete termische Pufferspeichern. ③ Heizverteiler mit Mischer. ④ Bodenheizung. ⑤ Solarstation. ⑥ Solarkollektoren. ⑦ Heizkoerper. ⑧ Gasheizkessel. ⑨ Brauchwasser. ⑩ Frischwasserzuleitung.
- ENG** ① Wood boiler. ② Thermocell 250/400/500, stratification thermal stores. ③ Mixing unit with floor heating manifold. ④ Floor heating system. ⑤ Mixing unit for solar manifold. ⑥ Solar heating unit. ⑦ Radiator. ⑧ Boiler. ⑨ Sanitary water output. ⑩ Water input.
- FRA** ① Générateur de chaleur à bois. ② Thermocell 250/400/500, ballon d'accumulation à stratification. ③ Groupe mélangeur pour l'installation du chauffage au sol. ④ Installation de chauffage au sol. ⑤ Groupe mélangeur pour les panneaux solaires. ⑥ Panneau solaire. ⑦ Radiateur. ⑧ Chaudière à gas. ⑨ Eau sanitaire. ⑩ Aqueduc.
- ESP** ① Calentador de leña. ② Thermocell 250/400/500, acumulación tèrmica a estratificaci3n. ③ Unidad de mezcla para losa radiante. ④ Suelo radiante. ⑤ Unidad de mezcla para placa solar. ⑥ Placa solar. ⑦ Radiadore. ⑧ Caldera de gas. ⑨ A.C.S. ⑩ Acueducto.



# INTEGRA TR-PACK

- ITA Thermostufa a legna abbinato a pannelli solari e accumuli.  
L'impianto termoidraulico deve essere realizzato secondo normativa locale e dotato di tutti gli accessori di sicurezza e controllo (legge 46/90 - Ispels, Uni ecc.).
- DEU Scheitholzoefen Wassergefuehrt mit Solar- und Speicheranschluss. Die Heizanlage muss die geltenden Bestimmungen befolgen und mit allen lokalen Sicherheits- und Kontrollelementen versehen sein.
- ENG Wood Thermostove paired to solar heating system. All installations must be realized following local current normatives and must be provided with check up and safety instruments.
- FRA Thermo poêle à bois accouplée aux panneaux solaire. L'installation de chauffage doit être réalisé suivant les réglementations locales et avoir tous les systèmes de sécurité et contrôle.
- ESP Calentador de leña combinado con placa solar. Cada instalación termohidráulica tiene que ser realizada según normativa local y dotada de todos los accesorios de seguridad y control.

THERMOPUFFER 400  
THERMOPUFFER 500  
Accumulo (puffer)  
Pufferspeicher  
Puffer tank  
Reservoir d'accumulation  
(puffer)  
Estanque (puffer)

THERMOLE\*2.0  
THERMOLE\*2.6  
Collettore solare  
Solarkollektoren  
Solar heating unit  
Panneaux solaire  
Placa solar



THERMOCELL 400®  
THERMOCELL 500®  
Accumuli a stratificazione  
Geschichtete termische  
Pufferspeichern  
Stratification thermal stores  
Ballon d'Accumulation à  
stratification  
Acumulació tèrmica a  
estratificació

Thermostufa a legna  
Scheitholzoefen Wassergefuehrt  
Wood Thermostove  
Thermo poêle à bois  
Calentador de leña



## 800 PU

- ITA** 800 PU canalizzabile si inserisce perfettamente negli ambienti più moderni donando calore e personalità. Il rivestimento è in maiolica refrattarie con finiture a puntini in sottilieve, sopra al focolare è presente uno scaldavivande e applicando il ventilatore è possibile distribuire il calore in più ambienti.
- DEU** Das kanalisierbare Modell 800 PU passt sich auch in das modernste Ambiente perfekt ein und verleiht ihm Wärme und Persönlichkeit. Die Verkleidung besteht aus feuerfesten Ofenkacheln, deren Oberflächenausführung kleine, nach innen gewölbte Punkte beinhaltet. Über dem Feuerraum befindet sich ein Warmhaltefach und mit Anwendung des Lüfters lässt sich die Wärme in mehreren Räumen verteilen.
- ENG** Model 800 PU with hot air channelling capability exudes warmth and personality and is the perfect solution for modern environments. It features a casing of refractory majolica tiles with a debossed dot motif, a food warmer above the firebox and with the simple application of a fan the heat can be distributed to several rooms.
- FRA** 800 PU canalisable s'adapte parfaitement aux milieux les plus modernes en offrant chaleur et personnalité. Le revêtement est en faïence réfractaire avec des finitions à petits points creux, un chauffe-plats est présent au dessus du foyer et en appliquant le ventilateur il est possible de distribuer la chaleur dans plusieurs pièces.
- ESP** El 800 PU canalizable se adapta perfectamente a los espacios más modernos, aportando calor y personalidad. El revestimiento es de mayólica refractaria con relieves cóncavos. Calientaplatos situado sobre el hogar. Al habilitar el ventilador se distribuye el calor a otros ambientes.

# 800 easy

Uscita canalizzazione disponibile:  
una posteriore  
Duct vent option: one rear



Vano scaldia vivande  
Food warming compartment

Ampio focolare  
(HxLxP-430x393x355)  
Large combustion chamber  
(HxLxD-430x393x355)

Maniglia antiscottatura  
Cool touch door handle

Ampio cassetto cenere estraibile  
Removable ash tray

Piano salva cenere in ghisa  
Cast iron ash collecting base

8m x 1  
4m x 2



opt. opt. opt. opt. opt. opt. opt. Air\*\* - Plus\*\*

## AIRBOX (optional)

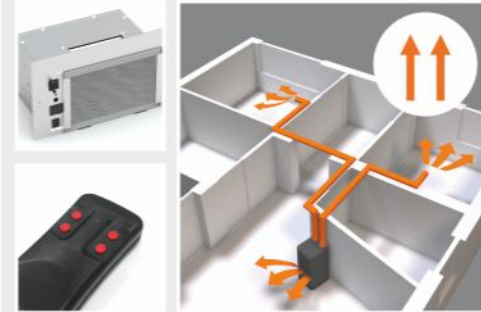

AIRBOX (optional): riscalda più ambienti, la stufa diventa ventilata e canalizzabile, radiocomando e filtro in dotazione  
AIRBOX (optional): it heats several rooms, the stoves becomes vented and air-ducting, radio control inclusive as standard

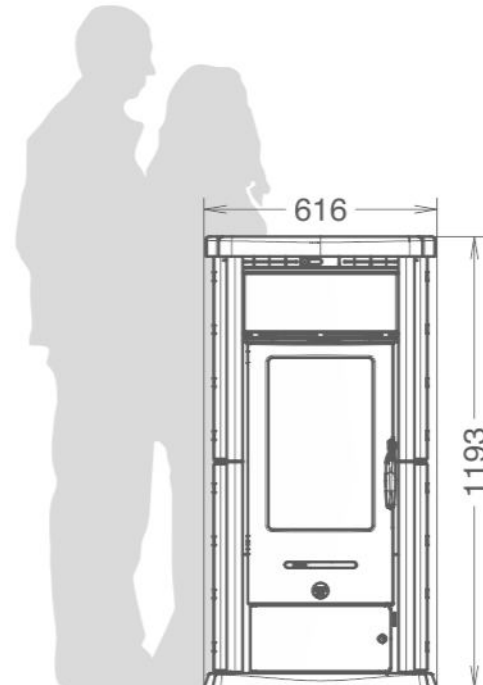

Easy

Easy

Maiolica PU

Sabbia del deserto

Beige

Bordeaux

Maiolica OV

Sabbia del deserto

Beige

Cuoio

Bordeaux

mm

1193x616x573

kW

15,6

kW NOM.

10,9

3,7

Kg

Easy 186  
Maiolica 218

\* Con sistema AirBox (optional) - With AirBox system (optional)



## 820 OV

- ITA 820 diventa protagonista della vostra casa, il rivestimento in pregiata maiolica avvolge un modello ricco di soluzioni tecniche in grado di distribuire l'aria calda fino a 4 ambienti in modo uniforme con notevole risparmio energetico.
- DEU Der Ofen 820 wird zum Mittelpunkt Ihres Zuhauses, die Verkleidung aus hochwertigen Kacheln umgibt ein Modell, das reich an technischen Lösungen und in der Lage ist, die Warmluft mit beträchtlicher Energieersparnis in bis zu 4 Räumen gleichmäßig zu verteilen.
- ENG The 820 will become an essential part of your home, with its distinctive majolica tile casing enclosing a heater packed with technical solutions capable of distributing hot air uniformly to 4 different spaces with considerable energy saving.
- FRA 820 devient le protagoniste de votre maison, le revêtement en précieuse faïence habille un modèle riche de solutions techniques en mesure de distribuer l'air chaud dans un maximum de 4 pièces de manière uniforme en permettant ainsi des économies d'énergie non négligeables.
- ESP El 820 se convierte en el protagonista de su casa: el revestimiento de preciada mayólica envuelve un modelo rico en soluciones técnicas capaz de distribuir el aire caliente incluso a otras 4 habitaciones de manera uniforme, con considerable ahorro energético.



# 820 easy

Uscite canalizzazioni disponibili: due posteriori  
Duct vents options: two rear



Scambiatore a fascio tubiero per canalizzazione aria calda con sistema Airbox\*  
Pipes heat exchanger for hot air ducting with Airbox\* system

Ampio focolare (HxLxD-430x393x355)  
Large combustion chamber (HxLxD-430x393x355)

Maniglia antiscottatura  
Cool touch door handle

Ampio cassetto cenere estraibile  
Removable ash tray

Piano salva cenere in ghisa  
Cast iron ash collecting base

16m x 4  
8m x 2  
6m x 2  
4m x 4

						opt.	opt.	opt.	opt.	opt.

Air\*\* - Plus\*\*

## AIRBOX (optional)

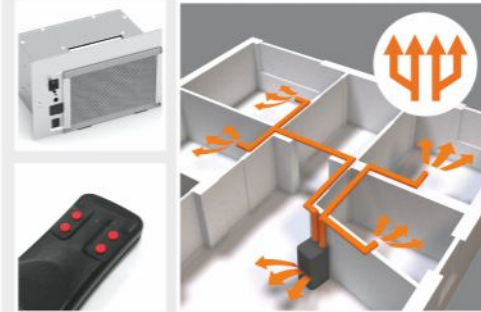

AIRBOX (optional): riscalda più ambienti, la stufa diventa ventilata e canalizzabile, radiocomando e filtro in dotazione  
AIRBOX (optional): it heats several rooms, the stoves becomes vented and air-ducting, radio control inclusive as standard

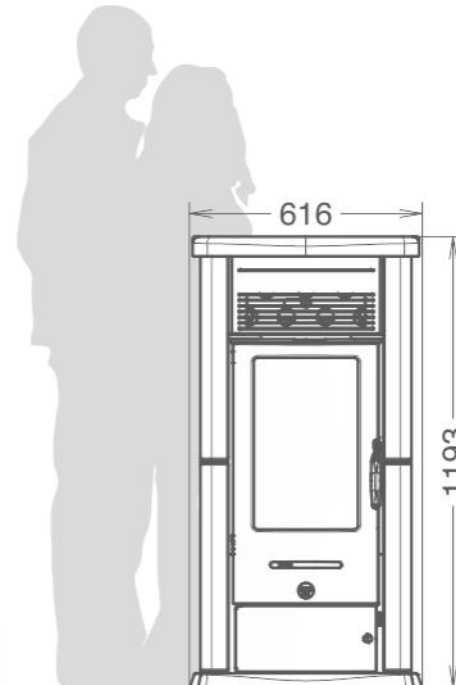

Easy	Easy	Maiolica PU	Sabbia del deserto	Beige	Bordeaux	Maiolica OV	Sabbia del deserto	Beige	Cuoio	Bordeaux	mm	1193x616x575	kW	15,6	kW NOM.	10,9	3,7	kg	198	223
------	------	-------------	--------------------	-------	----------	-------------	--------------------	-------	-------	----------	----	--------------	----	------	---------	------	-----	----	-----	-----

\* Con sistema AirBox (optional) - With AirBox system (optional)



## 860 OV

**ITA** Per i più esigenti 860 è dotata di forno smaltato con possibilità di canalizzare l'aria e riscaldare così più ambienti, questo modello è il migliore incontro tra tradizione e modernità. Basta un semplice click sul radiocomando per canalizzare l'aria calda senza rinunciare al piacere di assaporare squisite pietanze con i sapori di un tempo.

**DEU** Für anspruchsvolle Gemüter bietet das mit einem emaillierten Backofen ausgestattete Modell 860 als perfekte Verbindung zwischen Tradition und Moderne die Möglichkeit, Warmluft zu kanalisieren und so mehrere Räume zu beheizen. Es reicht ein einfacher Klick auf die Fernbedienungstaste, und die Warmluft wird umgelenkt, ohne auf den Genuss exquisiter Speisen mit dem Geschmack früherer Zeiten verzichten zu müssen.

**ENG** For more demanding needs 860 features an enamelled oven and has hot air channelling capability for heating several spaces. This model is the perfect blend of tradition and modernism. All it takes is a simple click on the radiocontrol to channel the hot air to various rooms while at the same time having the possibility of preparing and savouring exquisite traditional dishes.

**FRA** Pour les plus exigeants 860 est doté d'un four émaillé avec la possibilité de canaliser l'air et de chauffer ainsi plusieurs milieux. Ce modèle est la meilleure union entre la tradition et la modernité. Il suffit d'un simple clic sur la radiocommande pour canaliser l'air chaud sans renoncer au plaisir de savourer de délicieux petits plats aux saveurs d'autrefois.

**ESP** Para los más exigentes: la 860 está dotada de horno esmaltado con posibilidad de canalizar el aire y calentar así varios espacios. Este modelo es la mejor conjugación de tradición y modernidad. Con un simple clic en el radiomando se canaliza el aire caliente sin renunciar al placer de degustar platos exquisitos con los sabores de antaño.

# 860 easy

Uscita canalizzazione disponibile:  
una posteriore  
Duct vent option: one rear



Vano forno  
(HxLxP-260x310x300)  
Oven compartment  
(HxWxD-260x310x300)

Ampio focolare  
(HxLxP-430x393x355)  
Large combustion chamber  
(HxLxD-430x393x355)

Maniglia antiscottatura  
Cool touch door handle

Ampio cassetto cenere estraibile  
Removable ash tray

Piano salva cenere in ghisa  
Cast iron ash collecting base

## AIRBOX (optional)

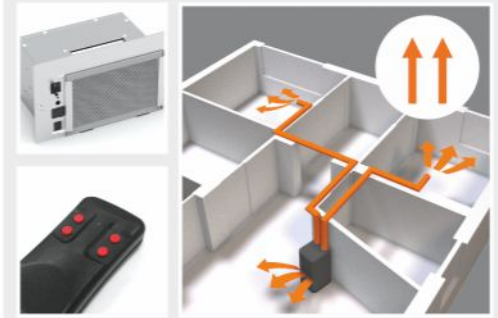

AIRBOX (optional): riscalda più ambienti, la stufa diventa ventilata e canalizzabile, radiocomando e filtro in dotazione  
AIRBOX (optional): it heats several rooms, the stoves becomes vented and air-ducting, radio control inclusive as standard

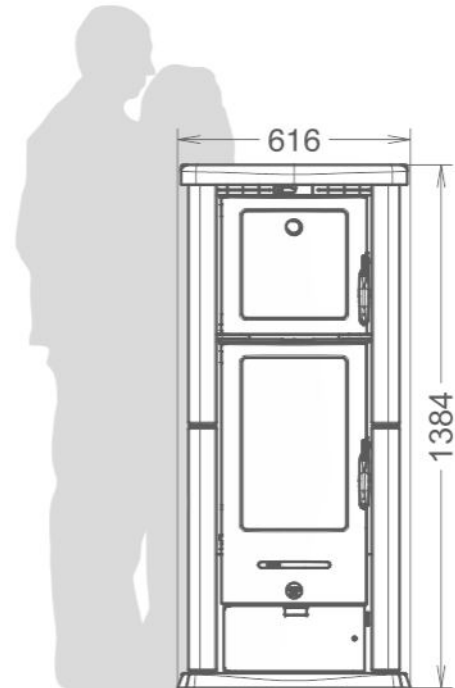

HxLxP 260x310x300		8m <sup>x</sup> 1 4m <sup>x</sup> 2		XXL		Easy Cleaning	EXTERNAL AIR INTAKE	Italy	4 YEARS	FIRST CLASS	36 decibel	AIR FILTER	AIRBOX
									opt.	opt.	opt.	opt.	opt.

Air\* - Plus\*

Easy

Easy

Maiolica PU

Sabbia del deserto

Beige

Bordeaux

Maiolica OV

Sabbia del deserto

Beige

Cuoio

Bordeaux

mm

1384x616x573

kW

15,6

kW NOM.

11,2

3,8

Kg

Easy 239  
Maiolica 271

\* Con sistema AirBox (optional) - With AirBox system (optional)



# VERTICALINE wood

- ITA** Monoblocco a legna compatto e canalizzabile con efficienza superiore (Wood 86,7% Wood hp 87,1%), camera di combustione rivestita da materiale refrattario ceramico HEATSTONE®. Verticaline è dotato dell'innovativa tecnologia Smoke by-pass: prima di ogni carica di legna, attivando il dispositivo, si riduce la fuoriuscita di fumo nell'ambiente domestico. Passive Hause: predisposizione per l'installazione all'interno di un'abitazione a basso consumo energetico con prelievo dell'aria comburente interamente dall'esterno. Riscalda più ambienti con il sistema di ventilazione optional AIRBOX. Inserendo questo accessorio il monoblocco diventa ventilato e canalizzabile con un'efficienza fino al 91%. Con AIRBOX si possono ridurre i consumi fino al 20% rispetto ad un monoblocco tradizionale. Radiocomando e filtro in dotazione.
- DEU** Der kanalisierbare Kachelofeneinsatz erreicht einen Wirkungsgrad von bis zu (Wood 86,7% / Wood hp 87,1%). Der Brennraum ist mit der keramischen HEATSTONE®. Technologie ausgestattet: Vor jedem Holz nachlegen schalten Sie die Rauchumlenkklappe um, damit beim Öffnen der Feuerraumtüre kein Rauch in den Aufstellraum entweichen kann. Passive House: Dies bietet die Möglichkeit den Ofen in einem Energiesparhaus unter der Verwendung des externen Zufuhranschlusses mit externer Zuluft zu versorgen. Dank der optionalen AIRBOX ist der Verticaline in der Lage, seine Wärme in mehr als ein Zimmer abzugeben. Mit dem zusätzlichen Gebläse erhöht sich die Effizienz des Gerätes bis zu 91%. Mit der AIRBOX kann der Wirkungsgrad bis zu 20% (im Vergleich zu einem traditionellen Holzofen) gesteigert werden (Fernbedienung und Luftfilter inklusive).
- ENG** Wood-burning and air-ducting stove, it performs to an efficiency more than (Wood 86,7% Wood hp 87,1%), Combustion area covered by the HEATSTONE®. Verticaline is equipped with the innovative Smoke by-pass technology: before every wood load and turning on an ad-hoc mechanic device, the stove reduces the smoke entering the living zone. Passive Hause: possibility to install the stove in a high energy-saving house using the external primary air input. Thanks to the optional AIRBOX venting system, Verticaline is able to heat more than one room: it becomes vented and air ducting with an efficiency up to 91%. With AIRBOX energy consumptions can be reduced of up to 20% compared to a traditional one. Remote control and air-filter inclusive as standard.
- FRA** Monobloc à bûches compact et canalisable, avec rendement supérieur a (Wood 86,7% Wood hp 87,1%), chambre de combustion habillée de matériel réfractaire-céramique HEATSTONE®. Le Verticaline est doté de l'innovante technologie Smoke by-pass : en activant ce système avant chaque recharge de combustible, il est possible de limiter l'émission de fumée dans la pièce. Passivhaus : prédisposition pour l'installation dans les habitations à basse consommation énergétique, avec apport d'air comburant exclusivement depuis l'extérieur. Réchauffez plusieurs pièces avec le système de ventilation optionnel AIRBOX. En insérant cet accessoire, le monobloc devient ventilé et canalisable, avec jusqu'à 91% de rendement. Avec l'AIRBOX, il est possible de réduire la consommation jusqu'à 20% par rapport à un monobloc traditionnel. Radiocommande et filtre (optional).

«L'efficienza fino al 91% permette di ridurre il consumo di legna fino al 20% rispetto ad un camino convenzionale»

«The efficiency of up to 91% reduces the wood consumption of up to 20% compared to a conventional fireplace»

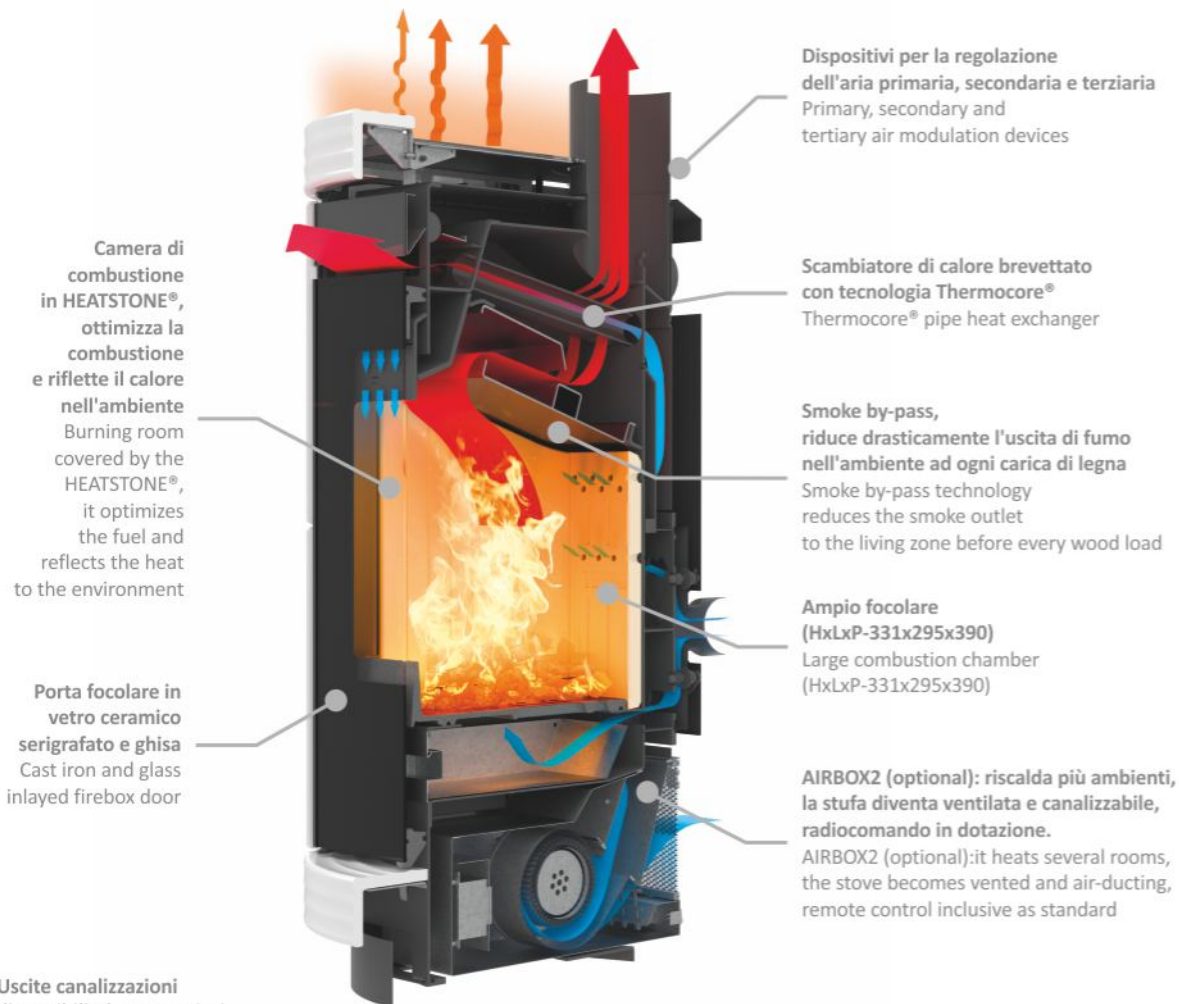

Uscite canalizzazioni disponibili: due posteriori  
Duct vents options: two rear

15m<sup>2</sup>  
5m<sup>2</sup>



opt. opt. opt. opt. opt. opt. opt. Air\* - Plus\*

AIRBOX (optional)

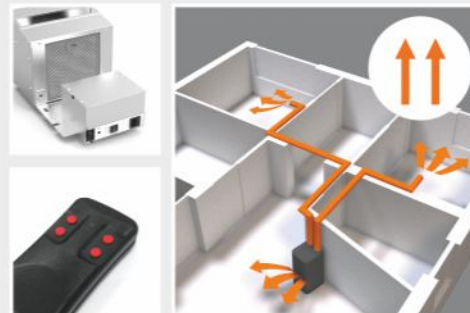

**AIRBOX2 (optional): riscalda più ambienti, la stufa diventa ventilata e canalizzabile, radiocomando e filtro in dotazione**

AIRBOX2 (optional): it heats several rooms, the stoves becomes vented and air-ducting, radio control inclusive as standard

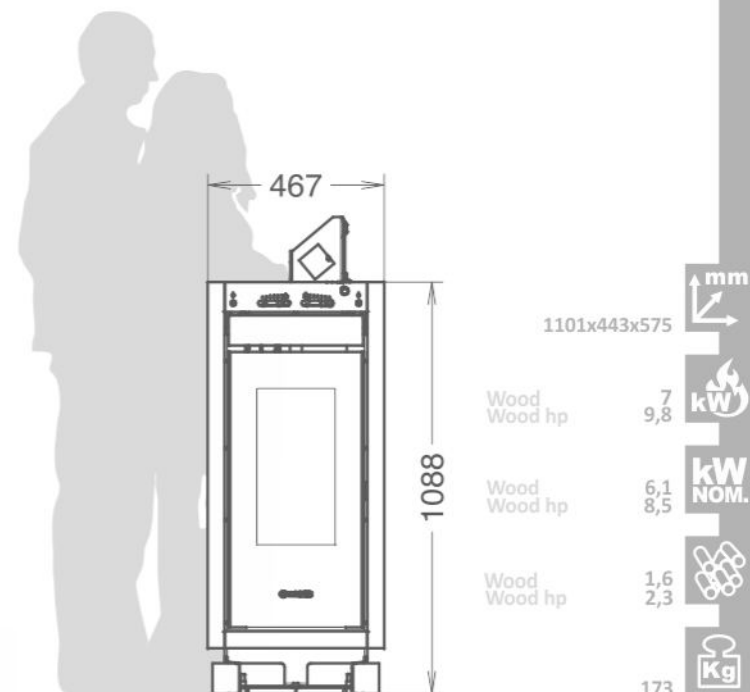

\* Con sistema AirBox2 (optional) - With AirBox2 system (optional)



# DORICA®

## Wood Metalcolor

**ITA** Stufa a legna canalizzabile con efficienza superiore (Wood 86,7% / Wood hp all'87,1%), camera di combustione rivestita da materiale refrattario ceramico HEATSTONE®. Dorica Wood è dotata dell'innovativa tecnologia Smoke by-pass: prima di ogni carica di legna, attivando il dispositivo, si riduce la fuoriuscita di fumo nell'ambiente domestico. Passive house: predisposizione per l'installazione all'interno di un'abitazione a basso consumo energetico con prelievo dell'aria comburente interamente dall'esterno. Riscalda più ambienti con il sistema di ventilazione optional AIRBOX. Inserendo questo accessorio la stufa diventa ventilata e canalizzabile con un'efficienza fino al 91%. Con AIRBOX si possono ridurre i consumi fino al 20% rispetto ad una stufa tradizionale. Radiocomando e filtro in dotazione.

**DEU** Der optional kanalisierbare Holzofen erreicht einen Wirkungsgrad von bis zu (Wood 86,7 / Wood hp 87,1%). Der Brennraum ist mit der keramischen HEATSTONE®. Dorica Wood ist mit der innovativen Smoke Bypass-Technologie ausgestattet: Vor jedem Holz nachlegen schalten Sie die Rauchumlenklappe um, damit beim Öffnen der Feuerraumtüre kein Rauch in den Aufstellraum entweichen kann. Passive House: Dies bietet die Möglichkeit den Ofen in einem Energiesparhaus unter der Verwendung des externen Zufuhranschlusses mit externer Zuluft zu versorgen. Dank der optionalen AIRBOX ist der Dorica Wood in der Lage, seine Wärme in mehr als ein Zimmer abzugeben. Mit dem zusätzlichen Gebläse erhöht sich die Effizienz des Gerätes bis zu 91%. Mit der AIRBOX kann der Wirkungsgrad bis zu 20% (im Vergleich zu einem traditionellen Holzofen) gesteigert werden (Fernbedienung und Luftfilter inklusive).

**ENG** Wood-burning and air-ducting stove, it performs to an efficiency of more than (Wood 86,7% / Wood hp 87,1%), firebox covered by the HEATSTONE®. Dorica Wood is equipped with the innovative Smoke by-pass technology: before every wood load and turning on an ad-hoc mechanic device, the stove reduces smoke entering the living zone. Passive House: possibility to install the stove into a high energy-saving house using the external primary air input. Thanks to the optional AIRBOX venting system, Dorica Wood is able to heat more than one room: it becomes vented and air-ducting with an efficiency up to 91%. Thanks to the AIRBOX System the energy consumption can be reduced of up to 20% compared to a traditional one. Remote control and air-filter inclusive as standard.

**FRA** Poêle à bûches canalisable, avec rendement supérieur à (Wood 86,7% / Wood hp all'87,1%), chambre de combustion habillée de matériel réfractaire-céramique HEATSTONE®. Les Dorica sont dotés de l'innovante technologie Smoke by-pass : en activant ce système avant chaque recharge de combustible, il est possible de limiter l'émission de fumée dans la pièce. Passivhaus : prédisposition pour l'installation dans les habitations à basse consommation énergétique, avec apport d'air comburant exclusivement depuis l'extérieur. Réchauffez plusieurs pièces avec le système de ventilation optionnel AIRBOX. En insérant cet accessoire, le poêle devient ventilé et canalisable, avec jusqu'à 91% de rendement. Avec l'AIRBOX, il est possible de réduire la consommation jusqu'à 20% par rapport à un monobloc traditionnel. Radiocommande et filtre (optional).

«L'efficienza fino al 91% permette di ridurre il consumo di legna fino al 20% rispetto ad una stufa convenzionale»

«The efficiency of up to 91% reduces the wood consumption of up to 20% compared to a conventional stove»

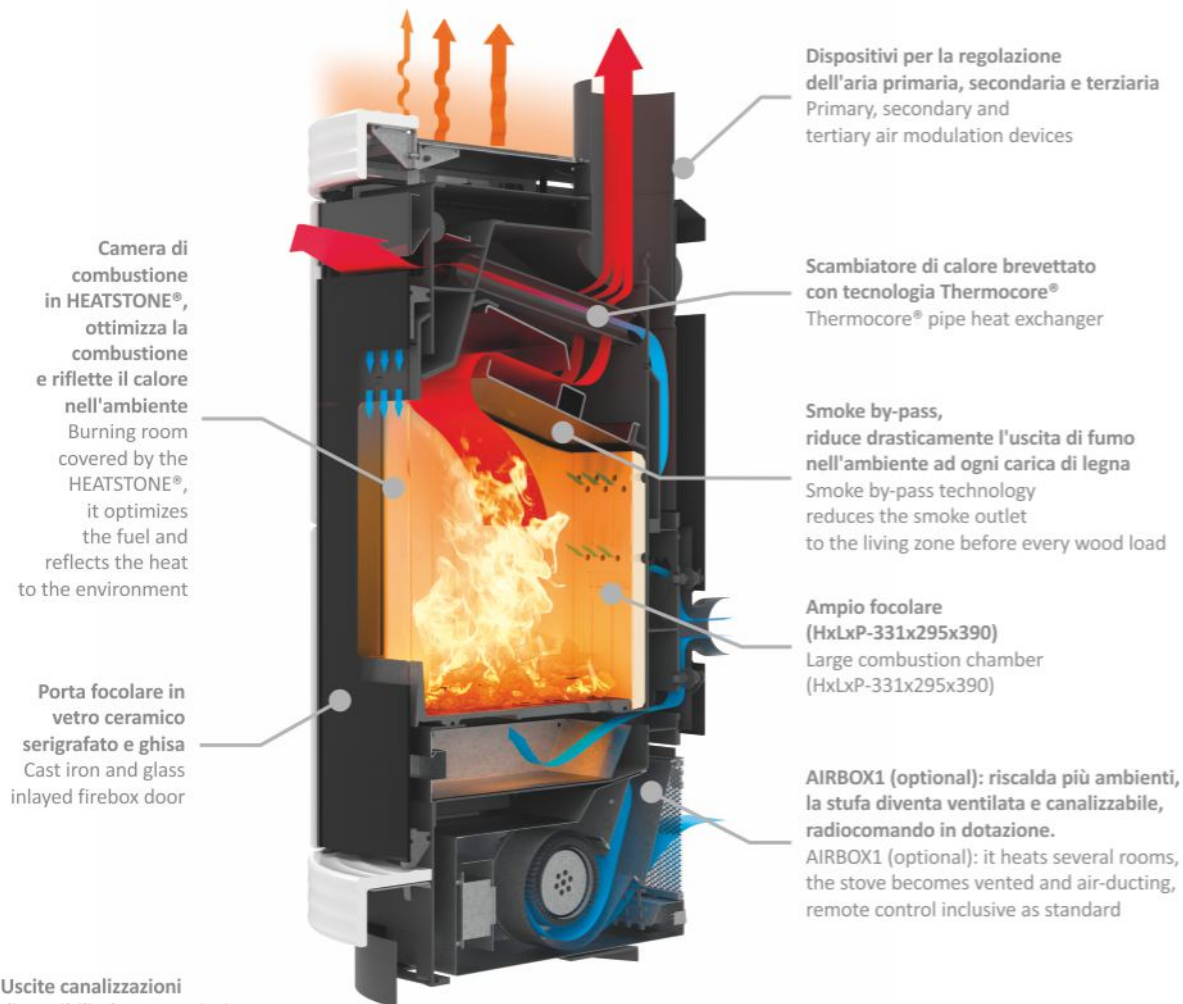

Uscite canalizzazioni disponibili: due posteriori  
Duct vents options: two rear

15mx1  
5mx2



opt. opt. opt. opt. opt. opt. opt. Air\* - Plus\*

AIRBOX (optional)

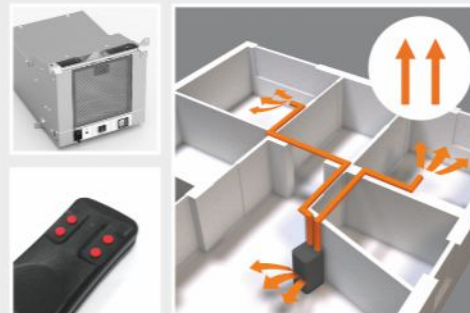

**AIRBOX1 (optional): riscalda più ambienti, la stufa diventa ventilata e canalizzabile, radiocomando e filtro in dotazione**  
AIRBOX1 (optional): it heats several rooms, the stoves becomes vented and air-ducting, radio control inclusive as standard

Grigio

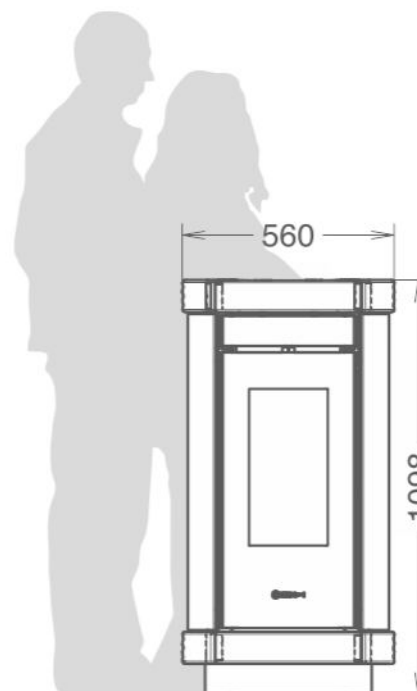

	mm
1095x560x612	
Wood Wood hp	7 9,8
Wood Wood hp	6,1 8,5
Wood Wood hp	1,6 2,3
	161

\* Con sistema AirBox1 (optional) - With AirBox1 system (optional)

silent - air - plus



# DORICA<sup>®</sup> Wood Maiolica

ITA Stufa a legna canalizzabile con efficienza superiore (Wood 86,7% / Wood hp all'87,1%), camera di combustione rivestita da materiale refrattario ceramico HEATSTONE<sup>®</sup>. Dorica Wood è dotata dell'innovativa tecnologia Smoke by-pass: prima di ogni carica di legna, attivando il dispositivo, si riduce la fuoriuscita di fumo nell'ambiente domestico. Passive house: predisposizione per l'installazione all'interno di un'abitazione a basso consumo energetico con prelievo dell'aria comburente interamente dall'esterno. Riscalda più ambienti con il sistema di ventilazione optional AIRBOX. Inserendo questo accessorio la stufa diventa ventilata e canalizzabile con un'efficienza fino al 91%. Con AIRBOX si possono ridurre i consumi fino al 20% rispetto ad una stufa tradizionale. Radiocomando e filtro in dotazione.

DEU Der optional kanalisierbare Holzofen erreicht einen Wirkungsgrad von bis zu (Wood 86,7 / Wood hp 87,1%). Der Brennraum ist mit der keramischen HEATSTONE<sup>®</sup>. Dorica Wood ist mit der innovativen Smoke Bypass-Technologie ausgestattet: Vor jedem Holz nachlegen schalten Sie die Rauchumlenklappe um, damit beim Öffnen der Feuerraumtüre kein Rauch in den Aufstellraum entweichen kann. Passive House: Dies bietet die Möglichkeit den Ofen in einem Energiesparhaus unter der Verwendung des externen Zufuhranschlusses mit externer Zuluft zu versorgen. Dank der optionalen AIRBOX ist der Dorica / Saint Moritz Wood in der Lage, seine Wärme in mehr als ein Zimmer abzugeben. Mit dem zusätzlichen Gebläse erhöht sich die Effizienz des Gerätes bis zu 91%. Mit der AIRBOX kann der Wirkungsgrad bis zu 20% (im Vergleich zu einem traditionellen Holzofen) gesteigert werden (Fernbedienung und Luftfilter inklusive).

ENG Wood-burning and air-ducting stove, it performs to an efficiency of more than (Wood 86,7% / Wood hp 87,1%), firebox covered by the HEATSTONE<sup>®</sup>. Dorica Wood is equipped with the innovative Smoke by-pass technology: before every wood load and turning on an ad-hoc mechanic device, the stove reduces smoke entering the living zone. Passive House: possibility to install the stove into a high energy-saving house using the external primary air input. Thanks to the optional AIRBOX venting system, Dorica Wood is able to heat more than one room: it becomes vented and air-ducting with an efficiency up to 91%. Thanks to the AIRBOX System the energy consumption can be reduced of up to 20% compared to a traditional one. Remote control and air-filter inclusive as standard.

FRA Poêle à bûches canalisable, avec rendement supérieur à (Wood 86,7% / Wood hp all'87,1%), chambre de combustion habillée de matériel réfractaire-céramique HEATSTONE<sup>®</sup>. Les Dorica sont dotés de l'innovante technologie Smoke by-pass : en activant ce système avant chaque recharge de combustible, il est possible de limiter l'émission de fumée dans la pièce. Passivhaus : prédisposition pour l'installation dans les habitations à basse consommation énergétique, avec apport d'air comburant exclusivement depuis l'extérieur. Réchauffez plusieurs pièces avec le système de ventilation optionnel AIRBOX. En insérant cet accessoire, le poêle devient ventilé et canalisable, avec jusqu'à 91% de rendement. Avec l'AIRBOX, il est possible de réduire la consommation jusqu'à 20% par rapport à un monobloc traditionnel. Radiocommande et filtre (optional).



«L'efficienza fino al 91% permette di ridurre il consumo di legna fino al 20% rispetto ad una stufa convenzionale»

«The efficiency of up to 91% reduces the wood consumption of up to 20% compared to a conventional stove»

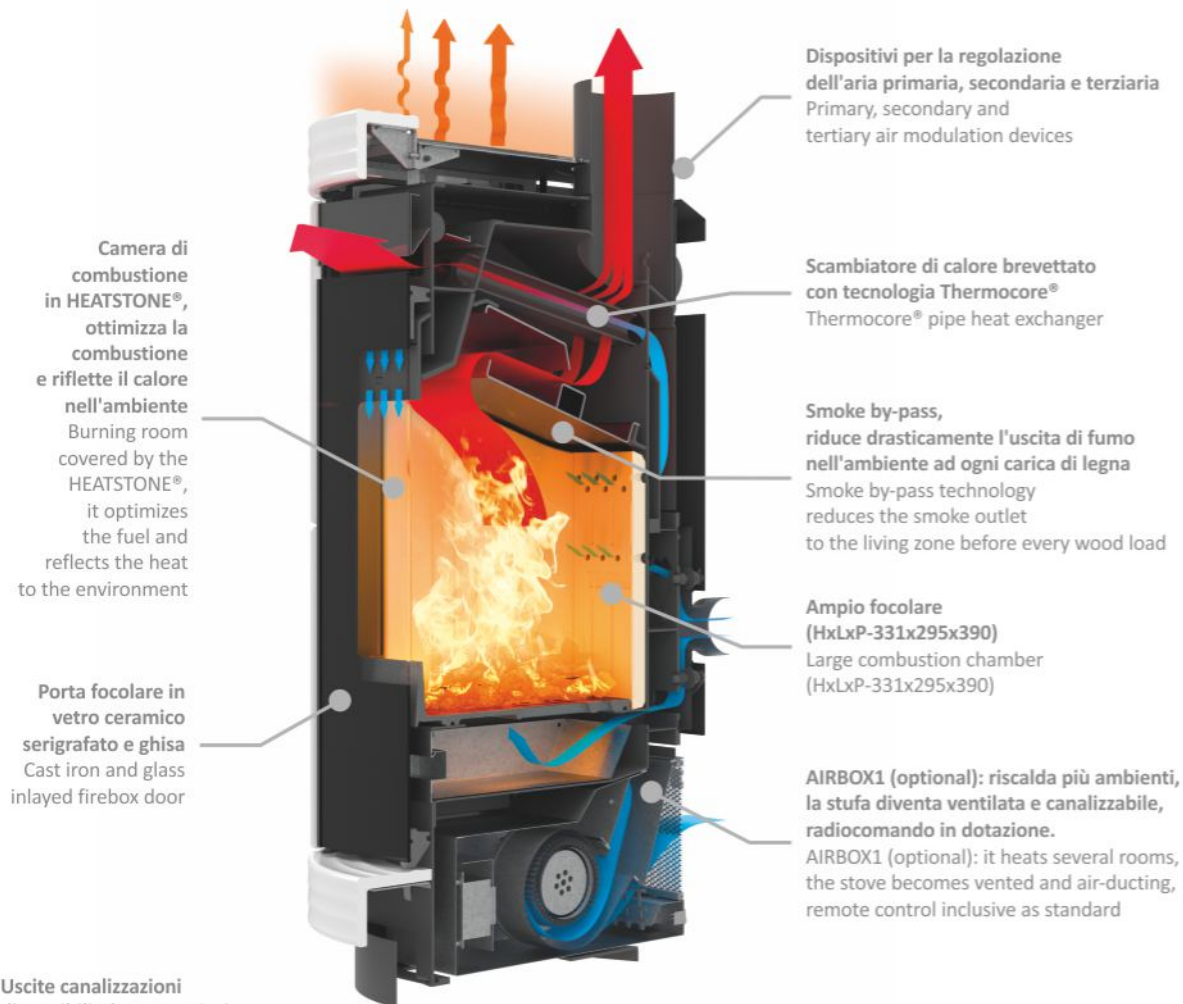

Uscite canalizzazioni disponibili: due posteriori  
Duct vents options: two rear

15mx1  
5mx2



opt. opt. opt. opt. opt. opt. opt. Air\* - Plus\*

AIRBOX (optional)

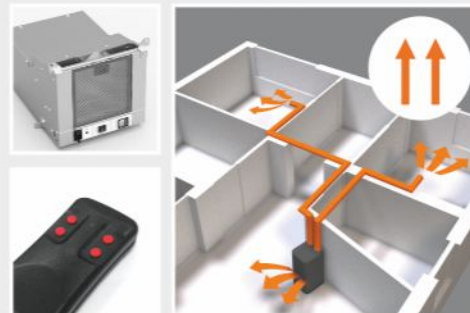

**AIRBOX1 (optional): riscalda più ambienti, la stufa diventa ventilata e canalizzabile, radiocomando e filtro in dotazione**

AIRBOX1 (optional): it heats several rooms, the stoves becomes vented and air-ducting, radio control inclusive as standard

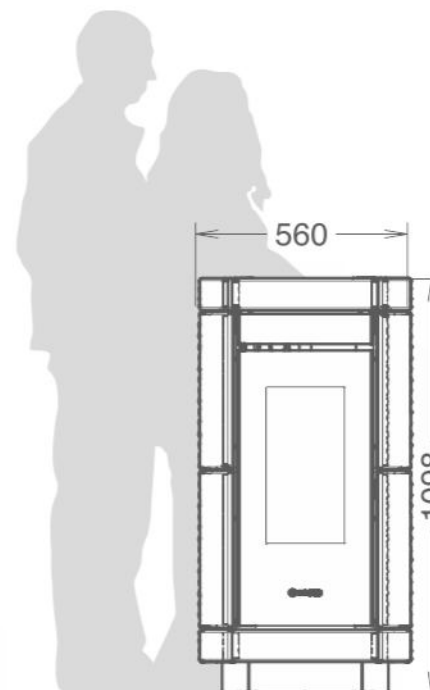

	mm	
1095x560x612		
Wood Wood hp	7 9,8	
Wood Wood hp	6,1 8,5	<b>kW NOM.</b>
Wood Wood hp	1,6 2,3	
	173	<b>Kg</b>

\* Con sistema AirBox1 (optional) - With AirBox1 system (optional)



# AROMY® Wood Metalcolor

- ITA** Stufa a legna canalizzabile con efficienza superiore (Wood 86,7% / Wood hp 87,1%), camera di combustione rivestita da materiale refrattario ceramico HEATSTONE®. Aromy Wood è dotata dell'innovativa tecnologia Smoke by-pass: prima di ogni carica di legna, attivando il dispositivo, si riduce la fuoriuscita di fumo nell'ambiente domestico. Passive house: predisposizione per l'installazione all'interno di un'abitazione a basso consumo energetico con prelievo dell'aria comburente interamente dall'esterno. Riscalda più ambienti con il sistema di ventilazione optional AIRBOX. Inserendo questo accessorio la stufa diventa ventilata e canalizzabile con un'efficienza fino al 91%. Con AIRBOX si possono ridurre i consumi fino al 20% rispetto ad una stufa tradizionale. Radiocomando e filtro in dotazione.
- DEU** Der optional kanalisierbare Holzofen erreicht einen Wirkungsgrad von bis zu (Wood 86,7% / Wood hp 87,1%). Der Brennraum ist mit der keramischen HEATSTONE®. Aromy Wood ist mit der innovativen Smoke Bypass-Technologie ausgestattet: Vor jedem Holz nachlegen schalten Sie die Rauchumlenklappe um, damit beim Öffnen der Feuerraumtüre kein Rauch in den Aufstellraum entweichen kann. Passive House: Dies bietet die Möglichkeit den Ofen in einem Energiesparhaus unter der Verwendung des externen Zufuhranschlusses mit externer Zuluft zu versorgen. Dank der optionalen AIRBOX ist der Aromy Wood in der Lage, seine Wärme in mehr als ein Zimmer abzugeben. Mit dem zusätzlichen Gebläse erhöht sich die Effizienz des Gerätes bis zu 91%. Mit der AIRBOX kann der Wirkungsgrad bis zu 20% (im Vergleich zu einem traditionellen Holzofen) gesteigert werden (Fernbedienung und Luftfilter inklusive).
- ENG** Wood-burning and air-ducting stove, it performs to an efficiency of more than (Wood 86,7% / Wood hp 87,1%), firebox covered by the HEATSTONE®. Aromy Wood is equipped with the innovative Smoke by-pass technology: before every wood load and turning on an ad-hoc mechanic device, the stove reduces smoke entering the living zone. Passive House: possibility to install the stove into a high energy-saving house using the external primary air input. Thanks to the optional AIRBOX venting system, Aromy Wood is able to heat more than one room: it becomes vented and air-ducting with an efficiency up to 91%. Thanks to the AIRBOX System the energy consumption can be reduced of up to 20% compared to a traditional one. Remote control and air-filter inclusive as standard.
- FRA** Poêle à bûches canalisable, avec rendement supérieur à (Wood 86,7% / Wood hp all'87,1%), chambre de combustion habillée de matériel réfractaire-céramique HEATSTONE®. Les Aromy sont dotés de l'innovante technologie Smoke by-pass : en activant ce système avant chaque recharge de combustible, il est possible de limiter l'émission de fumée dans la pièce. Passivhaus : prédisposition pour l'installation dans les habitations à basse consommation énergétique, avec apport d'air comburant exclusivement depuis l'extérieur. Réchauffez plusieurs pièces avec le système de ventilation optionnel AIRBOX. En insérant cet accessoire, le poêle devient ventilé et canalisable, avec jusqu'à 91% de rendement. Avec l'AIRBOX, il est possible de réduire la consommation jusqu'à 20% par rapport à un monobloc traditionnel. Radiocommande et filtre (optional).

«L'efficienza fino al 91% permette di ridurre il consumo di legna fino al 20% rispetto ad una stufa convenzionale»

«The efficiency of up to 91% reduces the wood consumption of up to 20% compared to a conventional stove»

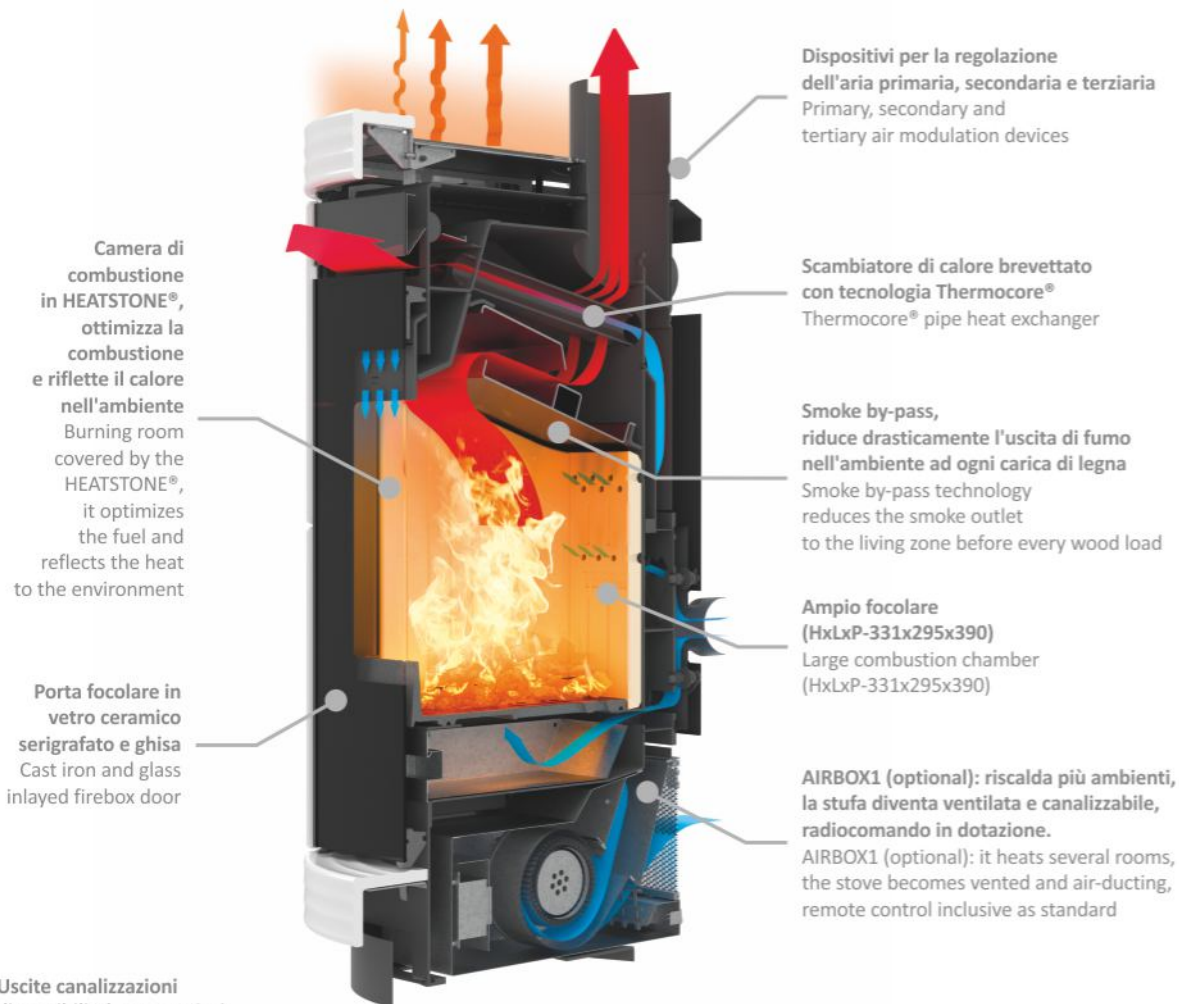

Uscite canalizzazioni disponibili: due posteriori  
Duct vents options: two rear

15m x 1  
5m x 2



opt. opt. opt. opt. opt. opt. opt. Air\* - Plus\*

AIRBOX (optional)



AIRBOX1 (optional): riscalda più ambienti, la stufa diventa ventilata e canalizzabile, radiocomando e filtro in dotazione

AIRBOX1 (optional): it heats several rooms, the stoves becomes vented and air-ducting, radio control inclusive as standard

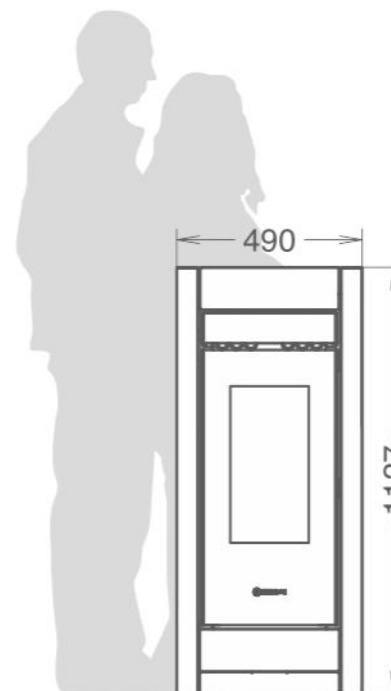

1127x490x566

Wood  
Wood hp

7  
9,8

Wood  
Wood hp

6,1  
8,5

Wood  
Wood hp

1,6  
2,3

181

Grigio

\* Con sistema AirBox1 (optional) - With AirBox1 system (optional)

silent - air - plus



## AROMY® Wood Stone

- ITA** Stufa a legna canalizzabile con efficienza superiore (Wood 86,7% / Wood hp 87,1%), camera di combustione rivestita da materiale refrattario ceramico HEATSTONE®. Aromy Wood è dotata dell'innovativa tecnologia Smoke by-pass: prima di ogni carica di legna, attivando il dispositivo, si riduce la fuoriuscita di fumo nell'ambiente domestico. Passive house: predisposizione per l'installazione all'interno di un'abitazione a basso consumo energetico con prelievo dell'aria comburente interamente dall'esterno. Riscalda più ambienti con il sistema di ventilazione optional AIRBOX. Inserendo questo accessorio la stufa diventa ventilata e canalizzabile con un'efficienza fino al 91%. Con AIRBOX si possono ridurre i consumi fino al 20% rispetto ad una stufa tradizionale. Radiocomando e filtro in dotazione.
- DEU** Der optional kanalisierbare Holzofen erreicht einen Wirkungsgrad von bis zu (Wood 86,7% / Wood hp 87,1%). Der Brennraum ist mit der keramischen HEATSTONE®. Aromy Wood ist mit der innovativen Smoke Bypass-Technologie ausgestattet: Vor jedem Holz nachlegen schalten Sie die Rauchumlenklappe um, damit beim Öffnen der Feuerraumtüre kein Rauch in den Aufstellraum entweichen kann. Passive House: Dies bietet die Möglichkeit den Ofen in einem Energiesparhaus unter der Verwendung des externen Zufuhranschlusses mit externer Zuluft zu versorgen. Dank der optionalen AIRBOX ist der Aromy Wood in der Lage, seine Wärme in mehr als ein Zimmer abzugeben. Mit dem zusätzlichen Gebläse erhöht sich die Effizienz des Gerätes bis zu 91%. Mit der AIRBOX kann der Wirkungsgrad bis zu 20% (im Vergleich zu einem traditionellen Holzofen) gesteigert werden (Fernbedienung und Luftfilter inklusive).
- ENG** Wood-burning and air-ducting stove, it performs to an efficiency of more than (Wood 86,7% / Wood hp 87,1%), firebox covered by the HEATSTONE®. Aromy Wood is equipped with the innovative Smoke by-pass technology: before every wood load and turning on an ad-hoc mechanic device, the stove reduces smoke entering the living zone. Passive House: possibility to install the stove into a high energy-saving house using the external primary air input. Thanks to the optional AIRBOX venting system, Aromy Wood is able to heat more than one room: it becomes vented and air-ducting with an efficiency up to 91%. Thanks to the AIRBOX System the energy consumption can be reduced of up to 20% compared to a traditional one. Remote control and air-filter inclusive as standard.
- FRA** Poêle à bûches canalisable, avec rendement supérieur à (Wood 86,7% / Wood hp all'87,1%), chambre de combustion habillée de matériel réfractaire-céramique HEATSTONE®. Les Aromy sont dotés de l'innovante technologie Smoke by-pass : en activant ce système avant chaque recharge de combustible, il est possible de limiter l'émission de fumée dans la pièce. Passivhaus : prédisposition pour l'installation dans les habitations à basse consommation énergétique, avec apport d'air comburant exclusivement depuis l'extérieur. Réchauffez plusieurs pièces avec le système de ventilation optionnel AIRBOX. En insérant cet accessoire, le poêle devient ventilé et canalisable, avec jusqu'à 91% de rendement. Avec l'AIRBOX, il est possible de réduire la consommation jusqu'à 20% par rapport à un monobloc traditionnel. Radiocommande et filtre (optional).

«L'efficienza fino al 91% permette di ridurre il consumo di legna fino al 20% rispetto ad una stufa convenzionale»

«The efficiency of up to 91% reduces the wood consumption of up to 20% compared to a conventional stove»

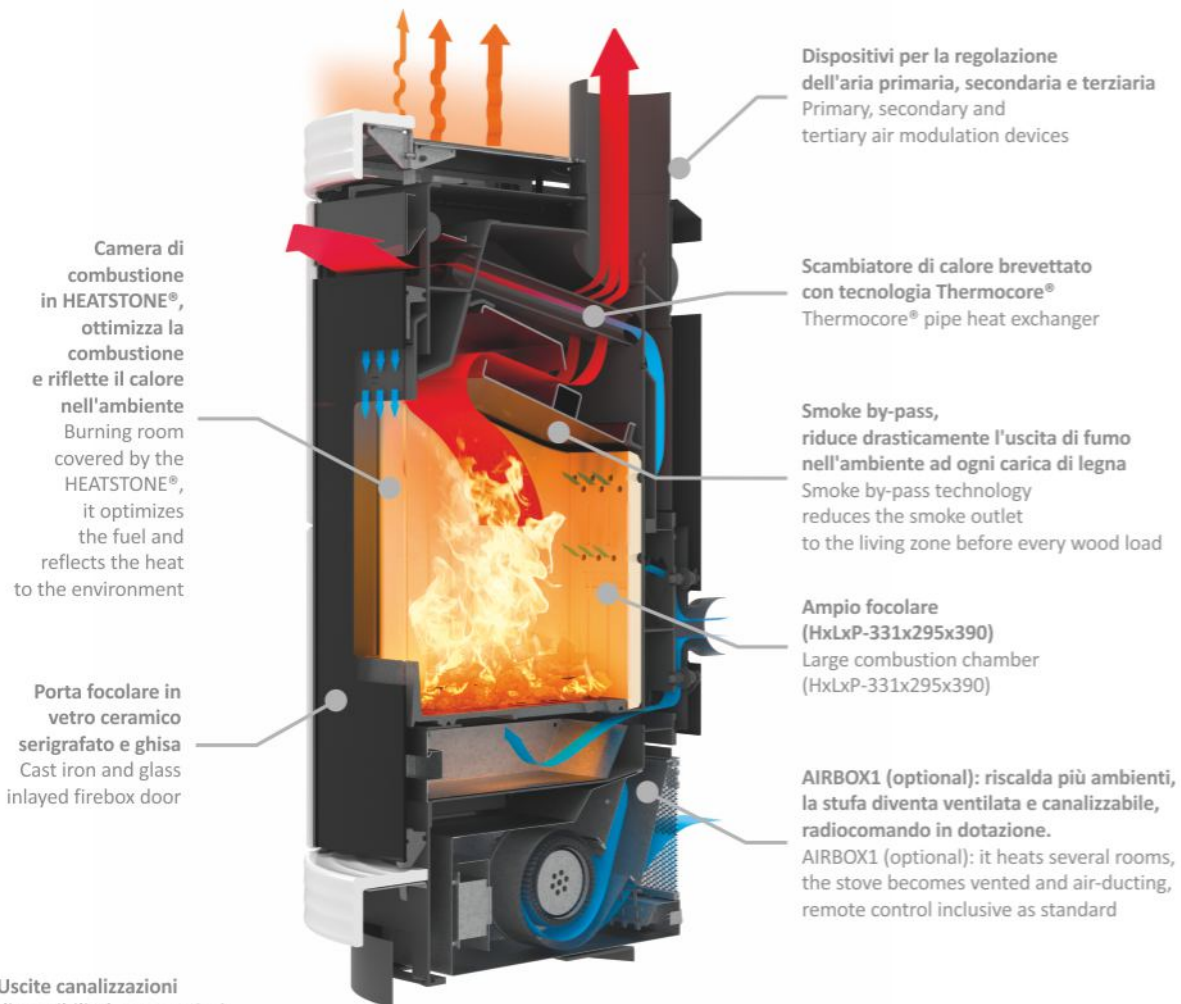

Uscite canalizzazioni disponibili: due posteriori  
Duct vents options: two rear

15mx1  
5mx2



opt. opt. opt. opt. opt. opt. opt. Air\* - Plus\*

AIRBOX (optional)



AIRBOX1 (optional): riscalda più ambienti, la stufa diventa ventilata e canalizzabile, radiocomando e filtro in dotazione

AIRBOX1 (optional): it heats several rooms, the stoves becomes vented and air-ducting, radio control inclusive as standard

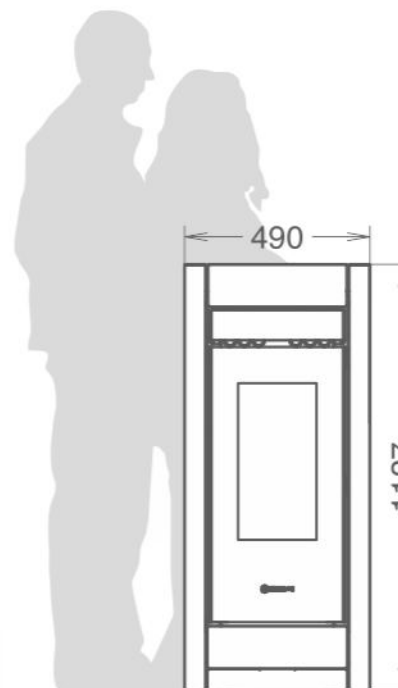

1127x490x566

Wood  
Wood hp

7  
9,8

Wood  
Wood hp

6,1  
8,5

Wood  
Wood hp

1,6  
2,3

220



Ollare

\* Con sistema AirBox1 (optional) - With AirBox1 system (optional)



# SAINT MORITZ® Wood

**ITA** Stufa a legna canalizzabile con efficienza superiore (Wood 86,7% / Wood hp all'87,1%), camera di combustione rivestita da materiale refrattario ceramico HEATSTONE®. Saint Moritz Wood è dotata dell'innovativa tecnologia Smoke by-pass: prima di ogni carica di legna, attivando il dispositivo, si riduce la fuoriuscita di fumo nell'ambiente domestico. Passive house: predisposizione per l'installazione all'interno di un'abitazione a basso consumo energetico con prelievo dell'aria comburente interamente dall'esterno. Riscalda più ambienti con il sistema di ventilazione optional AIRBOX. Inserendo questo accessorio la stufa diventa ventilata e canalizzabile con un'efficienza fino al 91%. Con AIRBOX si possono ridurre i consumi fino al 20% rispetto ad una stufa tradizionale. Radiocomando e filtro in dotazione.

**DEU** Der optional kanalisierbare Holzofen erreicht einen Wirkungsgrad von bis zu (Wood 86,7 / Wood hp 87,1%). Der Brennraum ist mit der keramischen HEATSTONE®. Saint Moritz Wood ist mit der innovativen Smoke Bypass-Technologie ausgestattet: Vor jedem Holz nachlegen schalten Sie die Rauchumlenkklappe um, damit beim Öffnen der Feuerraumtüre kein Rauch in den Aufstellraum entweichen kann. Passive House: Dies bietet die Möglichkeit den Ofen in einem Energiesparhaus unter der Verwendung des externen Zufuhranschlusses mit externer Zuluft zu versorgen. Dank der optionalen AIRBOX ist der Saint Moritz Wood in der Lage, seine Wärme in mehr als ein Zimmer abzugeben. Mit dem zusätzlichen Gebläse erhöht sich die Effizienz des Gerätes bis zu 91%. Mit der AIRBOX kann der Wirkungsgrad bis zu 20% (im Vergleich zu einem traditionellen Holzofen) gesteigert werden (Fernbedienung und Luftfilter inklusive).

**ENG** Wood-burning and air-ducting stove, it performs to an efficiency of more than (Wood 86,7% / Wood hp 87,1%), firebox covered by the HEATSTONE®. Saint Moritz Wood is equipped with the innovative Smoke by-pass technology: before every wood load and turning on an ad-hoc mechanic device, the stove reduces smoke entering the living zone. Passive House: possibility to install the stove into a high energy-saving house using the external primary air input. Thanks to the optional AIRBOX venting system, Saint Moritz Wood is able to heat more than one room: it becomes vented and air-ducting with an efficiency up to 91%. Thanks to the AIRBOX System the energy consumption can be reduced of up to 20% compared to a traditional one. Remote control and air-filter inclusive as standard.

**FRA** Poêle à bûches canalisable, avec rendement supérieur à (Wood 86,7% / Wood hp all'87,1%), chambre de combustion habillée de matériel réfractaire-céramique HEATSTONE®, base de chambre de combustion en fonte, airs primaire, secondaire et tertiaire, porte et contreporte en fonte, ample vitre-céramique avec sérigraphie, poignée de porte de foyer amovible, tiroir des cendres amovible, top en cristal, soupape de limitation de pression, plan ramasse-cendre en céramique. Les Saint Moritz sont dotés de l'innovante technologie Smoke by-pass : en activant ce système avant chaque recharge de combustible, il est possible de limiter l'émission de fumée dans la pièce. Passivhaus : prédisposition pour l'installation dans les habitations à basse consommation énergétique, avec apport d'air comburant exclusivement depuis l'extérieur. Réchauffez plusieurs pièces avec le système de ventilation optionnel AIRBOX. En insérant cet accessoire, le poêle devient ventilé et canalisable, avec jusqu'à 91% de rendement. Avec l'AIRBOX, il est possible de réduire la consommation jusqu'à 20% par rapport à un monobloc traditionnel. Radiocommande et filtre (optional).

«L'efficienza fino al 91% permette di ridurre il consumo di legna fino al 20% rispetto ad una stufa convenzionale»

«The efficiency of up to 91% reduces the wood consumption of up to 20% compared to a conventional stove»

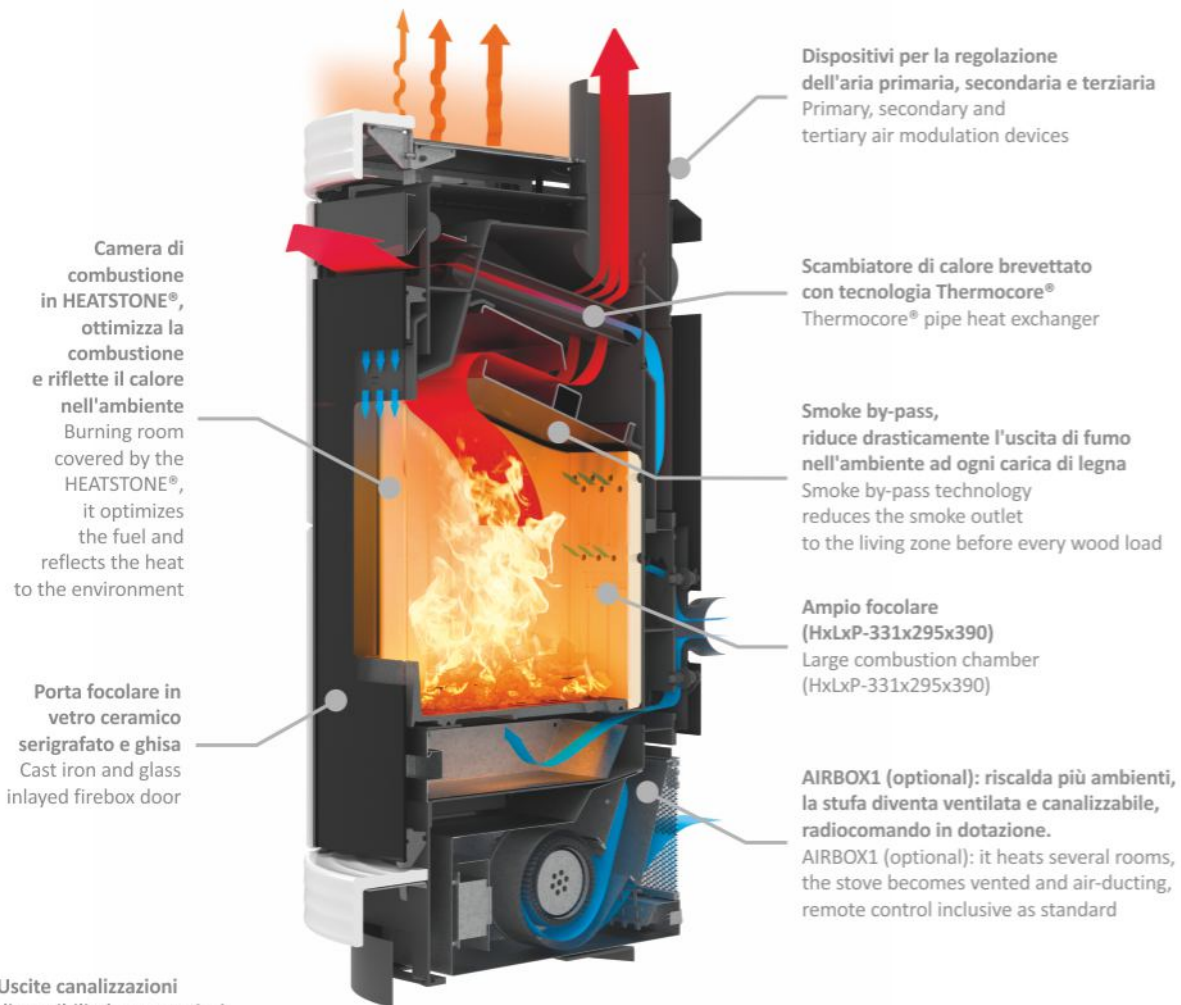

Uscite canalizzazioni disponibili: due posteriori  
Duct vents options: two rear

15mx1  
5mx2



opt. opt. opt. opt. opt. opt. opt. Air\* - Plus\*

**AIRBOX** (optional)

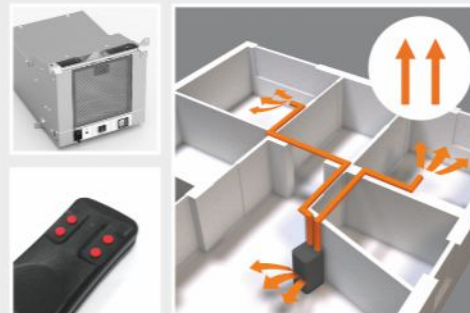

**AIRBOX1 (optional): riscalda più ambienti, la stufa diventa ventilata e canalizzabile, radiocomando e filtro in dotazione**  
AIRBOX1 (optional): it heats several rooms, the stoves becomes vented and air-ducting, radio control inclusive as standard

- Bianco
- Beige
- Tortora
- Bordeaux
- Bianco Beige
- Bianco Tortora
- Bianco Bordeaux

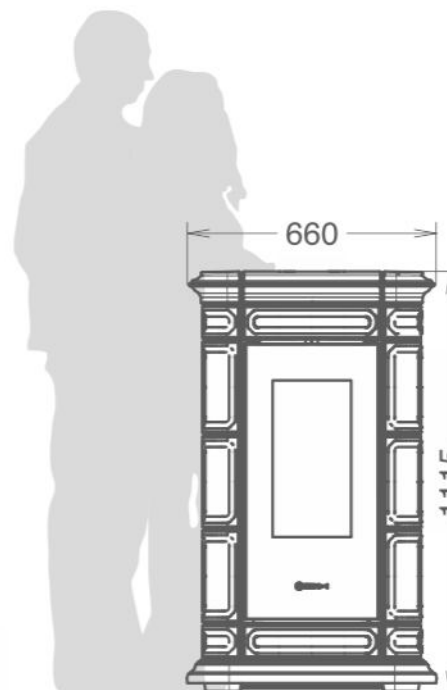

	mm	
1115x660x606		
Wood Wood hp	7 9,8	
Wood Wood hp	6,1 8,5	<b>kW NOM.</b>
Wood Wood hp	1,6 2,3	
	208	<b>kg</b>

\* Con sistema AirBox1 (optional) - With AirBox1 system (optional)

# LIENZ® Wood

**ITA** Stufa a legna canalizzabile con efficienza superiore (Wood 86,7 / Wood hp all'87,1%), dotata di un pratico vano scaldavivande a scomparsa in cristallo e maiolica, camera di combustione rivestita da materiale refrattario ceramico HEATSTONE®. Lienz Wood è dotata dell'innovativa tecnologia Smoke by-pass: prima di ogni carica di legna, attivando il dispositivo, si riduce la fuoriuscita di fumo nell'ambiente domestico. Passive house: predisposizione per l'installazione all'interno di un'abitazione a basso consumo energetico con prelievo dell'aria comburente interamente dall'esterno. Riscalda più ambienti con il sistema di ventilazione optional AIRBOX. Inserendo questo accessorio la stufa diventa ventilata e canalizzabile con un'efficienza fino al 91%. Con AIRBOX si possono ridurre i consumi fino al 20% rispetto ad una stufa tradizionale. Radiocomando e filtro in dotazione.

**DEU** Der optional kanalisierbare Holzofen erreicht einen Wirkungsgrad von bis zu (Wood 86,7% / Wood hp 87,1%). Der Brennraum ist mit der keramischen HEATSTONE®. Lienz Wood ist mit der innovativen Smoke Bypass-Technologie ausgestattet: Vor jedem Holz nachlegen schalten Sie die Rauchumlenklappe um, damit beim Öffnen der Feuerraumtüre kein Rauch in den Aufstellraum entweichen kann. Passive House: Dies bietet die Möglichkeit den Ofen in einem Energiesparhaus unter der Verwendung des externen Zufuhranschlusses mit externer Zuluft zu versorgen. Dank der optionalen AIRBOX ist der Lienz Wood in der Lage, seine Wärme in mehr als ein Zimmer abzugeben. Mit dem zusätzlichen Gebläse erhöht sich die Effizienz des Gerätes bis zu 91%. Mit der AIRBOX kann der Wirkungsgrad bis zu 20% (im Vergleich zu einem traditionellen Holzofen) gesteigert werden (Fernbedienung und Luftfilter inklusive).

**ENG** Wood-burning and air-ducting stove, it performs to an efficiency of more than (Wood 86,7 / Wood hp 87,1%), firebox covered by the HEATSTONE® Lienz Wood Hp is equipped with the innovative Smoke by-pass technology: before every wood load and turning on an ad-hoc mechanic device, the stove reduces smoke entering the living zone. Passive House: possibility to install the stove into a high energy-saving house using the external primary air input. Thanks to the optional AIRBOX venting system, Lienz Wood Hp is able to heat more than one room: it becomes vented and air-ducting with an efficiency up to 91%. Thanks to the AIRBOX System the energy consumption can be reduced of up to 20% compared to a traditional one. Remote control and air-filter inclusive as standard (optional).

**FRA** Poêle à bûches canalisable, avec rendement supérieur à (Wood 86,7 / Wood hp 87,1%), tiroir-chauffe-plat pratique et coulissant, en cristal et céramique, chambre de combustion habillée de matériel réfractaire-céramique HEATSTONE®. Les Lienz sont dotés de l'innovante technologie Smoke by-pass sont dotés de l'innovante technologie Smoke by-pass: en activant ce système avant chaque recharge de combustible, il est possible de limiter l'émission de fumée dans la pièce. Passivhaus : prédisposition pour l'installation dans les habitations à basse consommation énergétique, avec apport d'air comburant exclusivement depuis l'extérieur. Réchauffez plusieurs pièces avec le système de ventilation optionnel AIRBOX. En insérant cet accessoire, le poêle devient ventilé et canalisable, avec jusqu'à 91% de rendement. Avec l'AIRBOX, il est possible de réduire la consommation jusqu'à 20% par rapport à un monobloc traditionnel. Radiocommande et filtre (optional).



«L'efficienza fino al 91% permette di ridurre il consumo di legna fino al 20% rispetto ad una stufa convenzionale»

«The efficiency of up to 91% reduces the wood consumption of up to 20% compared to a conventional stove»



Dispositivi per la regolazione dell'aria primaria, secondaria e terziaria  
Primary, secondary and tertiary air modulation devices

Scambiatore di calore brevettato con tecnologia Thermocore®  
Thermocore® pipe heat exchanger

Smoke by-pass, riduce drasticamente l'uscita di fumo nell'ambiente ad ogni carica di legna  
Smoke by-pass technology reduces the smoke outlet to the living zone before every wood load

Ampio focolare (HxLxP-331x295x390)  
Large combustion chamber (HxLxP-331x295x390)

AIRBOX1 (optional): riscalda più ambienti, la stufa diventa ventilata e canalizzabile, radiocomando in dotazione.  
AIRBOX1 (optional): it heats several rooms, the stove becomes vented and air-ducting, remote control inclusive as standard

Camera di combustione in HEATSTONE®, ottimizza la combustione e riflette il calore nell'ambiente  
Burning room covered by the HEATSTONE®, it optimizes the fuel and reflects the heat to the environment

Porta focolare in vetro ceramico serigrafato e ghisa  
Cast iron and glass inlaid firebox door

Uscite canalizzazioni disponibili: due posteriori  
Duct vents options: two rear

15mx1  
5mx2



opt. opt. opt. opt. opt. opt. opt. Air\* - Plus\*

AIRBOX (optional)



AIRBOX1 (optional): riscalda più ambienti, la stufa diventa ventilata e canalizzabile, radiocomando e filtro in dotazione  
AIRBOX1 (optional): it heats several rooms, the stoves becomes vented and air-ducting, radio control inclusive as standard

- Bianco
- Beige
- Tortora
- Bordeaux
- Bianco Beige
- Bianco Tortora
- Bianco Bordeaux

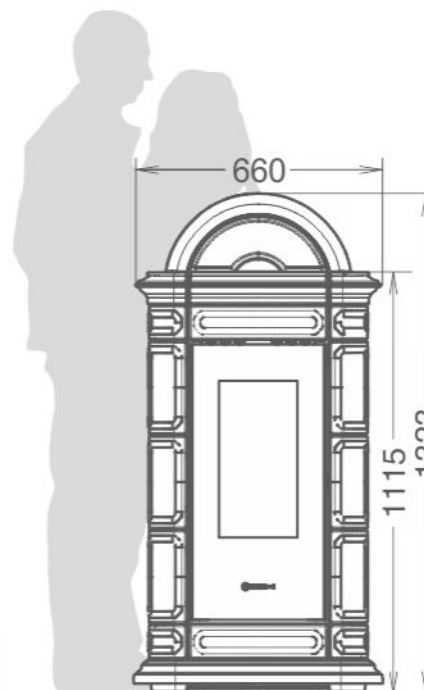

1323x660x608

Wood  
Wood hp

7  
9,8 kW

Wood  
Wood hp

6,1  
8,5 kW NOM.

Wood  
Wood hp

1,6  
2,3 kW

224 Kg

\* Con sistema AirBox1 (optional) - With AirBox1 system (optional)



# MONTREUX<sup>®</sup> Wood

- ITA** Stufa a legna canalizzabile con efficienza superiore (Wood 86,7 / Wood hp all'87,1%), dotata di un pratico vano scaldavivande a scomparsa in cristallo e maiolica, camera di combustione rivestita da materiale refrattario ceramico HEATSTONE<sup>®</sup>. Montreux Wood è dotata dell'innovativa tecnologia Smoke by-pass: prima di ogni carica di legna, attivando il dispositivo, si riduce la fuoriuscita di fumo nell'ambiente domestico. Passive house: predisposizione per l'installazione all'interno di un'abitazione a basso consumo energetico con prelievo dell'aria comburente interamente dall'esterno. Riscalda più ambienti con il sistema di ventilazione optional AIRBOX. Inserendo questo accessorio la stufa diventa ventilata e canalizzabile con un'efficienza fino al 91%. Con AIRBOX si possono ridurre i consumi fino al 20% rispetto ad una stufa tradizionale. Radiocomando e filtro in dotazione.
- DEU** Der optional kanalisierbare Holzofen erreicht einen Wirkungsgrad von bis zu (Wood 86,7% / Wood hp 87,1%). Der Brennraum ist mit der keramischen HEATSTONE<sup>®</sup>. Montreux Wood ist mit der innovativen Smoke Bypass-Technologie ausgestattet: Vor jedem Holz nachlegen schalten Sie die Rauchumlenklappe um, damit beim Öffnen der Feuerraumtüre kein Rauch in den Aufstellraum entweichen kann. Passive House: Dies bietet die Möglichkeit den Ofen in einem Energiesparhaus unter der Verwendung des externen Zufuhranschlusses mit externer Zuluft zu versorgen. Dank der optionalen AIRBOX ist der Montreux Wood in der Lage, seine Wärme in mehr als ein Zimmer abzugeben. Mit dem zusätzlichen Gebläse erhöht sich die Effizienz des Gerätes bis zu 91%. Mit der AIRBOX kann der Wirkungsgrad bis zu 20% (im Vergleich zu einem traditionellen Holzofen) gesteigert werden (Fernbedienung und Luftfilter inklusive).
- ENG** Wood-burning and air-ducting stove, it performs to an efficiency of more than (Wood 86,7 / Wood hp 87,1%), firebox covered by the HEATSTONE<sup>®</sup> Montreux Wood Hp is equipped with the innovative Smoke by-pass technology: before every wood load and turning on an ad-hoc mechanic device, the stove reduces smoke entering the living zone. Passive House: possibility to install the stove into a high energy-saving house using the external primary air input. Thanks to the optional AIRBOX venting system, Montreux Wood Hp is able to heat more than one room: it becomes vented and air-ducting with an efficiency up to 91%. Thanks to the AIRBOX System the energy consumption can be reduced of up to 20% compared to a traditional one. Remote control and air-filter inclusive as standard (optional).
- FRA** Poêle à bûches canalisable, avec rendement supérieur à (Wood 86,7 / Wood hp 87,1%), tiroir-chauffe-plat pratique et coulissant, en cristal et céramique, chambre de combustion habillée de matériel réfractaire-céramique HEATSTONE<sup>®</sup>. Les Montreux sont dotés de l'innovante technologie Smoke by-pass sont dotés de l'innovante technologie Smoke by-pass: en activant ce système avant chaque recharge de combustible, il est possible de limiter l'émission de fumée dans la pièce. Passivhaus : prédisposition pour l'installation dans les habitations à basse consommation énergétique, avec apport d'air comburant exclusivement depuis l'extérieur. Réchauffez plusieurs pièces avec le système de ventilation optionnel AIRBOX. En insérant cet accessoire, le poêle devient ventilé et canalisable, avec jusqu'à 91% de rendement. Avec l'AIRBOX, il est possible de réduire la consommation jusqu'à 20% par rapport à un monobloc traditionnel. Radiocommande et filtre (optional).

«L'efficienza fino al 91% permette di ridurre il consumo di legna fino al 20% rispetto ad una stufa convenzionale»

«The efficiency of up to 91% reduces the wood consumption of up to 20% compared to a conventional stove»

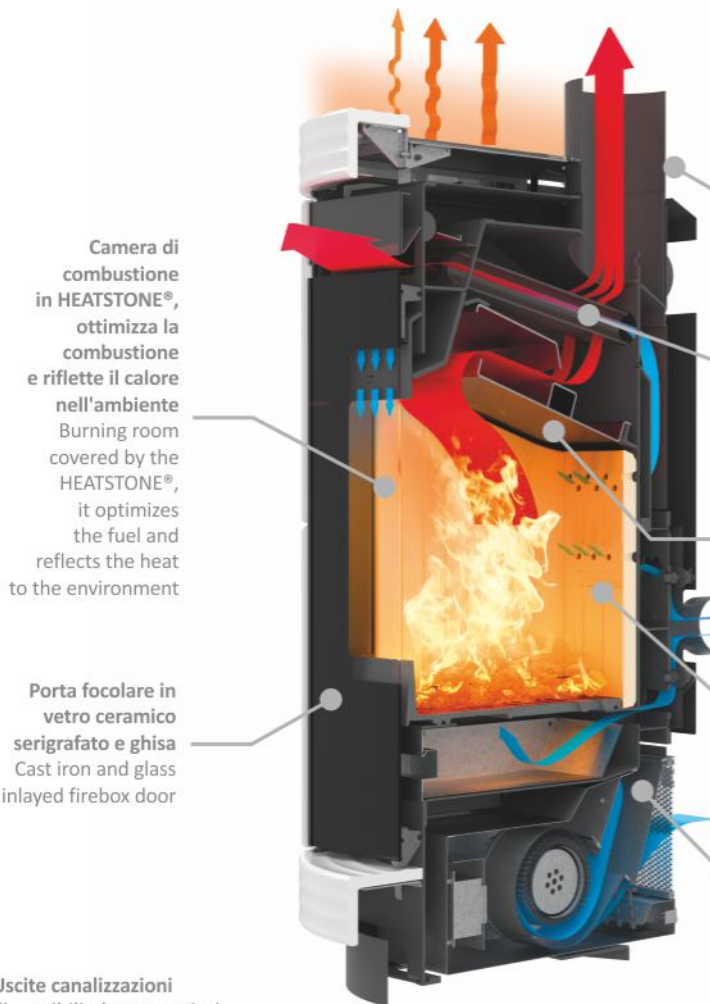

Camera di combustione in HEATSTONE®, ottimizza la combustione e riflette il calore nell'ambiente  
Burning room covered by the HEATSTONE®, it optimizes the fuel and reflects the heat to the environment

Porta focolare in vetro ceramico serigrafato e ghisa  
Cast iron and glass inlaid firebox door

Uscite canalizzazioni disponibili: due posteriori  
Duct vents options: two rear

Dispositivi per la regolazione dell'aria primaria, secondaria e terziaria  
Primary, secondary and tertiary air modulation devices

Scambiatore di calore brevettato con tecnologia Thermocore®  
Thermocore® pipe heat exchanger

Smoke by-pass, riduce drasticamente l'uscita di fumo nell'ambiente ad ogni carica di legna  
Smoke by-pass technology reduces the smoke outlet to the living zone before every wood load

Ampio focolare (HxLxP-331x295x390)  
Large combustion chamber (HxLxP-331x295x390)

AIRBOX1 (optional): riscalda più ambienti, la stufa diventa ventilata e canalizzabile, radiocomando in dotazione.  
AIRBOX1 (optional): it heats several rooms, the stove becomes vented and air-ducting, remote control inclusive as standard

15mx1  
5mx2



opt. opt. opt. opt. opt. opt. opt. Air\* - Plus\*

AIRBOX (optional)



AIRBOX1 (optional): riscalda più ambienti, la stufa diventa ventilata e canalizzabile, radiocomando e filtro in dotazione  
AIRBOX1 (optional): it heats several rooms, the stoves becomes vented and air-ducting, radio control inclusive as standard

- Bianco
- Beige
- Tortora
- Bordeaux
- Bianco Beige
- Bianco Tortora
- Bianco Bordeaux

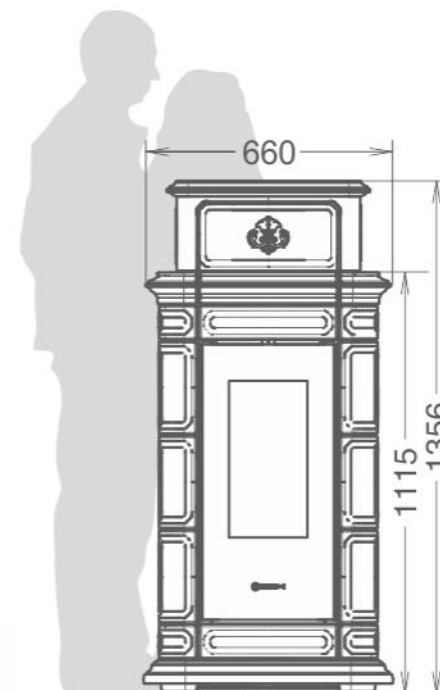

	mm	
1356x660x613		
Wood Wood hp	7 9,8	kW
Wood Wood hp	6,1 8,5	kW NOM.
Wood Wood hp	1,6 2,3	
	232	Kg

\* Con sistema AirBox1 (optional) - With AirBox1 system (optional)



## Vision maiolica

ITA Il piacere del benessere. La massima espressione di tecnologia e prestazioni, per chi non vuole rinunciare al fascino del fuoco e vuole riscaldare l'intera abitazione. La grande camera di combustione è rivestita dalla preziosa maiolica e dal prestigioso vetro panoramico arrotondato. Di serie il sistema di ventilazione gestito con radiocomando è capace di distribuire l'aria calda in diversi ambienti.

DEU Freude am Wohlbefinden. Die höchste Ausprägung von Technik und Leistung für diejenigen unter uns, die nicht auf die Faszination eines Feuers verzichten, gleichzeitig aber den gesamten Wohnraum beheizen wollen. Der große Brennraum ist von wertvollen Kacheln und einem optisch ansprechenden, gewölbten Panoramafenster umgeben. Mit der fernbedienten, serienmäßig vorhandenen Lüftungsanlage lässt sich die Warmluft auf mehrere Räume verteilen.

ENG The pleasure of wellness. The maximum expression of technology and performance, for those who enjoy watching the flickering flames of the burning fire yet want to heat the entire house. The large firebox is enclosed within the distinctive majolica tile casing and the panoramic curved glass. The radio-controlled ventilation system capable of distributing hot air to various different rooms is a standard feature of this model.

FRA Le plaisir du bien-être. L'expression maximale de la technologie et des performances, pour tous ceux qui ne veulent pas renoncer au charme du feu et souhaitent chauffer toute la maison. La grande chambre de combustion est habillée de précieuse faïence et fermée par une prestigieuse vitre panoramique aux formes arrondies. Le système de ventilation monté en série et géré par radiocommande est capable de distribuer l'air chaud dans plusieurs milieux.

ESP El placer del bienestar. La máxima expresión de tecnología y prestaciones para aquellos que no quieren renunciar a la sugestión del fuego al calentar toda la habitación. La gran cámara de combustión está revestida con preciada mayólica y prestigioso vidrio panorámico redondeado. Sistema de ventilación en serie, gestionado con radiomando capaz de distribuir el aire caliente a otros ambientes.

# Vision inox



Preziosa maiolica artigianale fatta a mano  
Precious handmade majolica by master craftsmen

Vano scalda vivande  
Food warming compartment

Vetro panoramico curvo con serigrafia nera  
Curved panoramic glass with black silkscreen

Ampio focolare  
(HxLxP-430x460x320)  
Large combustion chamber  
(HxLxD-430x460x320)

Maniglia antiscottatura  
Cool-touch door handle

Ampio cassetto cenere estraibile  
Removable ash tray

Piano salva cenere in ghisa  
Cast iron ash collecting base

Uscita canalizzazione disponibile:  
una posteriore  
Duct vent option: one rear

16m x 1  
8m x 2  
6m x 3  
4m x 4

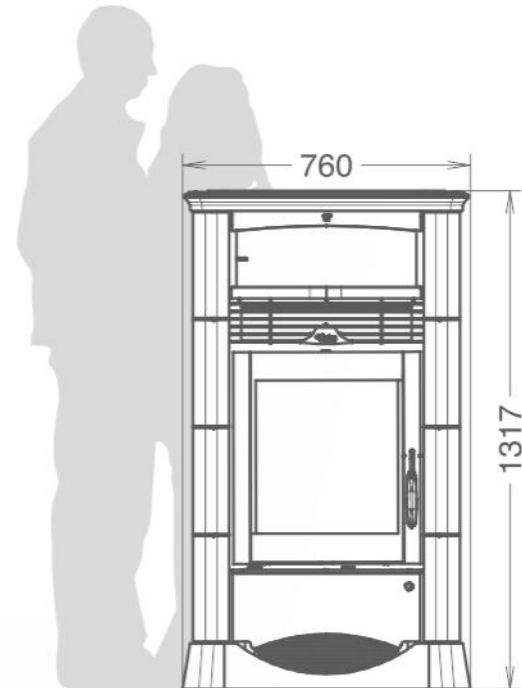

Maiolica

Bianco

Beige

Bordeaux

Nero

Inox

Maiolica nera e Inox

1317x760x583

17,4

13,9

4,0

Inox 272  
Maiolica 298



# IONICA TimeXtend® Wood Metalcolor TimeXtend® Wood hp Metalcolor

- ITA** Stufa a legna dotata di accumulatore inerziale con efficienza superiore (Wood 85,3% / Wood hp 83,5%), camera di combustione rivestita da materiale refrattario ceramico HEATSTONE®. Tecnologia TimeXtend®: accumulo inerziale progettato per recuperare e trattenere il calore sprigionato dai gas di combustione. TimeXtend® è contraddistinto da 4 canali di passaggio fumi, ricavati da un pesante blocco di refrattario. Il passaggio dei gas attraverso i 4 canali, determina una cessione del calore doppia rispetto ad altre realizzazioni costruite da un unico passaggio. Grazie alla sua massa termica, il calore viene trattenuto durante il processo di combustione, successivamente rilasciato in modo graduale nell'arco di diverse ore anche a fuoco spento.
- DEU** Der Speicher- Holzofen mit integrierten Wärmespeichersteinen erreicht einen Wirkungsgrad von bis zu (Holz 85,3% / Holz hp 83,5%), Der Brennraum ist mit der keramischen HEATSTONE®. Die TimeXtend® Technologie ist mit Wärmespeichersteinen konstruiert um die Energie der Abgase thermisch nutzbar zu machen. Der massive Speicherblock TimeXtend® ist mit 4 Kanäle für die Rauchgasabführung ausgestattet. Durch die 4 Kanäle durch die Speicherblock wird die benötigte Aufheizzeit der Speichermasse um 50% gegenüber einem einzigen Kanal durch die Speicherblock reduziert. Selbst viele Stunden nachdem das Feuer erloschen ist, gibt dieser Speicherblock noch Wärme in den Aufstellraum ab.
- ENG** Wood-burning stove equipped with thermic inertial accumulation, it performs to an efficiency of more than (Wood 85,3% / Wood hp 83,5%), Firebox covered by HEATSTONE®. TimeXtend® technology: thermic inertial accumulation designed to recover and retain the combustion heat. TimeXtend® is distinguished by 4 smoke output channels, derived from heavy fire-resistant material mono block. The transition of hot smokes through the 4 channels performs a thermic exchange which is double more than other one-channel solutions. Thanks to its thermic block, the heat is held back during the combustion phase, afterwards gradually released over several hours, also after the fire is extinguished.
- FRA** Poêle à bûches doté d'un accumulateur de chaleur à inertie, avec rendement supérieur à ( wood 85,3% / wood hp 83,5%), chambre de combustion habillée de matériel réfractaire-céramique HEATSTONE®. Technologie TimeXtend® : accumulateur thermique à inertie projeté pour récupérer et conserver la chaleur dégagée par les gaz de combustion. Le TimeXtend® se distingue grâce à ses 4 canaux de passage de fumée creusés dans un bloc massif de pierre réfractaire. Le passage des gaz à travers ces 4 canaux détermine une cession de chaleur deux fois plus importante que dans les solutions à un passage unique. Grâce à sa masse thermique, la chaleur est accumulée pendant la phase de combustion, et successivement cédée graduellement pendant plusieurs heures, bien après l'extinction du feu.

Preziosa maiolica artigianale  
fatta a mano  
Precious handmade majolica  
by master craftsmen

Porta focolare  
in vetro ceramico  
serigrafato e ghisa  
Cast iron and glass  
inlaid firebox door

Ampio focolare  
(HxLxP-342x282x382)  
Large combustion chamber  
(HxLxD-342x282x382)

Piano salva cenere  
Ash collecting base

Dispositivi per la regolazione  
dell'aria primaria,  
secondaria e terziaria  
Primary, secondary and  
tertiary air modulation devices

TimeXtend®,  
massa termica che si riscalda  
grazie ai suoi esclusivi 4 canali.  
Il calore viene trattenuto e rilasciato  
in modo graduale nell'arco di diverse ore  
anche a fuoco spento  
TimeXtend® technology:  
thermic inertial accumulation  
thanks to the exclusive 4 channels.  
The heat is recovered and gradually  
released towards several hours,  
also after the fire is extinguished

Smoke by-pass,  
riduce drasticamente  
l'uscita di fumo  
nell'ambiente ad ogni  
carica di legna

Smoke by-pass technology  
reduces the smoke outlet  
to the living zone  
before every wood load

Camera di combustione  
in HEATSTONE®,  
ottimizza la combustione e  
riflette il calore nell'ambiente  
Burning room covered by  
the HEATSTONE®,  
it optimizes the fuel and reflects  
the heat to the environment

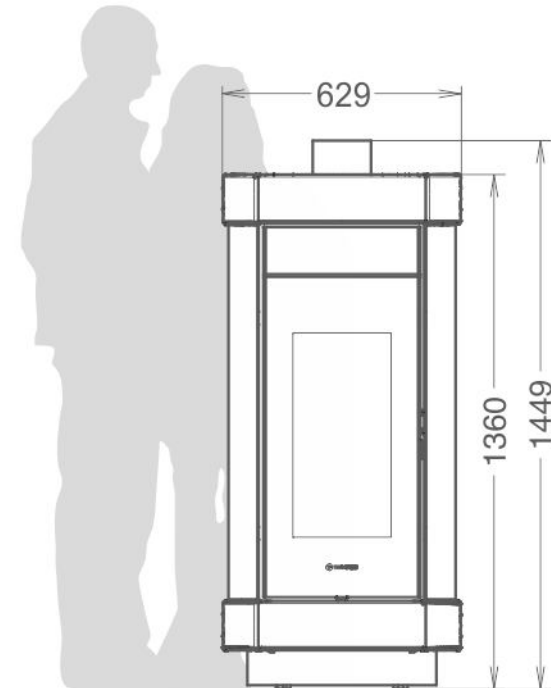
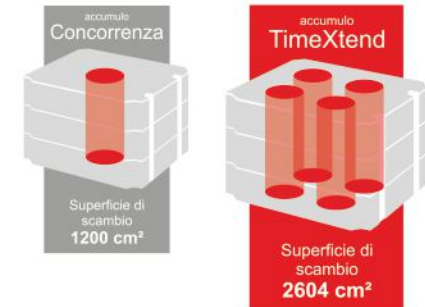
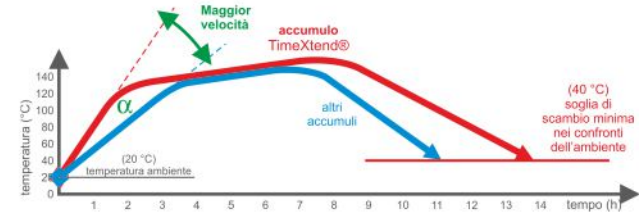

1449x629x639

Model	Power (kW)	Weight (Kg)
Timextend hp	9,2	303
Timextend hp	12,4	303
Timextend hp	7,9	303
Timextend hp	10,4	303
Timextend hp	2,2	303
Timextend hp	2,9	303





# IONICA

TimeXtend® Wood Maiolica  
TimeXtend® Wood hp Maiolica

- ITA Stufa a legna dotata di accumulatore inerziale con efficienza superiore (Wood 85,3% / Wood hp 83,5%), camera di combustione rivestita da materiale refrattario ceramico HEATSTONE®. Tecnologia TimeXtend®: accumulo inerziale progettato per recuperare e trattenere il calore sprigionato dai gas di combustione. TimeXtend® è contraddistinto da 4 canali di passaggio fumi, ricavati da un pesante blocco di refrattario. Il passaggio dei gas attraverso i 4 canali, determina una cessione del calore doppia rispetto ad altre realizzazioni costruite da un unico passaggio. Grazie alla sua massa termica, il calore viene trattenuto durante il processo di combustione, successivamente rilasciato in modo graduale nell'arco di diverse ore anche a fuoco spento.
- DEU Der Speicher- Holzofen mit integrierten Wärmespeichersteinen erreicht einen Wirkungsgrad von bis zu (Holz 85,3% / Holz hp 83,5%), Der Brennraum ist mit der keramischen HEATSTONE®. Die TimeXtend® Technologie ist mit Wärmespeichersteinen konstruiert um die Energie der Abgase thermisch nutzbar zu machen. Der massive Speicherblock TimeXtend® ist mit 4 Kanäle für die Rauchgasabführung ausgestattet. Durch die 4 Kanäle durch die Speicherblock wird die benötigte Aufheizzeit der Speichermasse um 50% gegenüber einem einzigen Kanal durch die Speicherblock reduziert. Selbst viele Stunden nachdem das Feuer erloschen ist, gibt dieser Speicherblock noch Wärme in den Aufstellraum ab.
- ENG Wood-burning stove equipped with thermic inertial accumulation, it performs to an efficiency of more than (Wood 85,3% / Wood hp 83,5%), Firebox covered by HEATSTONE®. TimeXtend® technology: thermic inertial accumulation designed to recover and retain the combustion heat. TimeXtend® is distinguished by 4 smoke output channels, derived from heavy fire-resistant material mono block. The transition of hot smokes through the 4 channels performs a thermic exchange which is double more than other one-channel solutions. Thanks to its thermic block, the heat is held back during the combustion phase, afterwards gradually released over several hours, also after the fire is extinguished.
- FRA Poêle à bûches doté d'un accumulateur de chaleur à inertie, avec rendement supérieur à ( wood 85,3% / wood hp 83,5%), chambre de combustion habillée de matériel réfractaire-céramique HEATSTONE®. Technologie TimeXtend® : accumulateur thermique à inertie projeté pour récupérer et conserver la chaleur dégagée par les gaz de combustion. Le TimeXtend® se distingue grâce à ses 4 canaux de passage de fumée creusés dans un bloc massif de pierre réfractaire. Le passage des gaz à travers ces 4 canaux détermine une cession de chaleur deux fois plus importante que dans les solutions à un passage unique. Grâce à sa masse thermique, la chaleur est accumulée pendant la phase de combustion, et successivement cédée graduellement pendant plusieurs heures, bien après l'extinction du feu.



Preziosa maiolica artigianale  
fatta a mano  
Precious handmade majolica  
by master craftsmen

Porta focolare  
in vetro ceramico  
serigrafato e ghisa  
Cast iron and glass  
inlaid firebox door

Ampio focolare  
(HxLxP-342x282x382)  
Large combustion chamber  
(HxLxD-342x282x382)

Piano salva cenere  
Ash collecting base

Dispositivi per la regolazione  
dell'aria primaria,  
secondaria e terziaria  
Primary, secondary and  
tertiary air modulation devices

TimeXtend®,  
massa termica che si riscalda  
grazie ai suoi esclusivi 4 canali.  
Il calore viene trattenuto e rilasciato  
in modo graduale nell'arco di diverse ore  
anche a fuoco spento  
TimeXtend® technology:  
thermic inertial accumulation  
thanks to the exclusive 4 channels.  
The heat is recovered and gradually  
released towards several hours,  
also after the fire is extinguished

Smoke by-pass,  
riduce drasticamente  
l'uscita di fumo  
nell'ambiente ad ogni  
carica di legna

Smoke by-pass technology  
reduces the smoke outlet  
to the living zone  
before every wood load

Camera di combustione  
in HEATSTONE®,  
ottimizza la combustione e  
riflette il calore nell'ambiente  
Burning room covered by  
the HEATSTONE®,  
it optimizes the fuel and reflects  
the heat to the environment

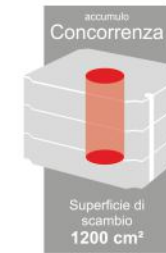
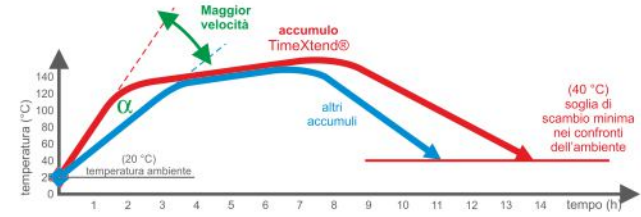

Bianco

Beige

Tortora

Bordeaux

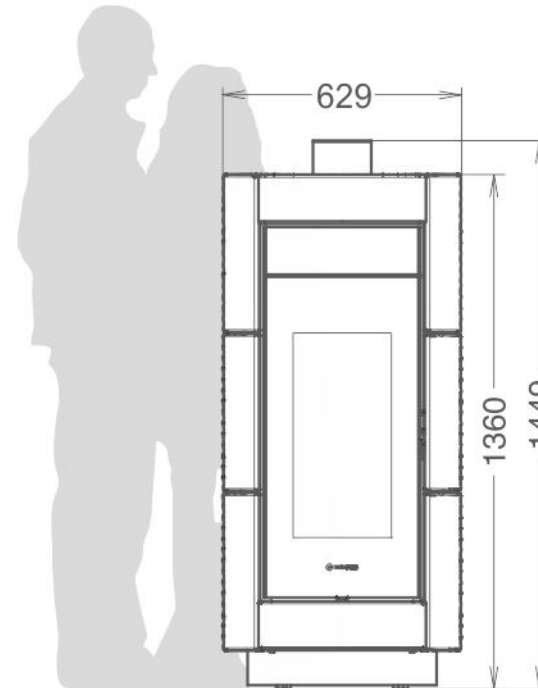

1449x629x639

mm

Timextend 9,2 kW

Timextend hp 12,4

Timextend 7,9 kW NOM.

Timextend hp 10,4

Timextend 2,2

Timextend hp 2,9

Timextend 319 Kg

Timextend hp 319





**BOSKY**

silent

## Chef-F maiolica fiori

ITA Dall'esperienza acquisita da più di 40 anni nella produzione di termocucine a legna abbiamo realizzato la cucina CHEF, con prestazioni ed emissioni sorprendenti. Un prodotto ecologico che primeggia nella sua categoria per le sue caratteristiche uniche.

DEU Die Erfahrung aus mehr als 40 Jahren in der Produktion von Scheitholzküchenherd Wassergeführt, haben wir den Küchenherd CHEF realisiert, der mit erstaunlichen Arbeitsleistungen und niedrigen Emissionen, ist der erste Produkt in seiner Klasse.

ENG If you want the best in wood fired cooking, this is it. High technology, Thermorossi ingenuity and all the experience gained in over 40 years of cooker manufacturing have gone into the production of our latest range of cookers and we are proud to introduce the Bosky Chef.

FRA La cuisinière CHEF, avec ses prestations et ses émissions surprenantes, nait de l'expérience acquise par plus de 40 ans de production de thermo-cuisinières à buches: ce produit est la première cuisinière à buches de sa catégorie.

ESP De la experiencia adquirida en más de 40 años de producción de termo cocinas de leña ha nacido el producto de cocina Chef, de eficiencias y emisiones admirables, que la destacan como el producto estrella de su categoría.

# Chef maiolica fiori

Uscite fumi disponibili: posteriore - superiore  
Flue outlet options: rear - top

Piano cottura in acciaio inox.  
Optional: Serie di cerchi in ghisa e piano vetrificato.  
Stainless steel cooking plate.  
Optional: cast iron rings and vitrified cooking plate

Corrimano laterale (optional)  
Lateral handrail (optional)

Ampio focolare  
(HxLxP-376x266x416)  
Large combustion chamber  
(HxLxD-376x266x416)

Maniglia anticottatura  
Cool touch door handle

Preziosa maiolica artigianale fatta a mano  
Precious handmade majolica by master craftsmen

Tecnologia «easy cleaning»  
«Easy cleaning» technology

Aria primaria  
Primary air control

Aria secondaria  
Secondary air

Ampio cassetto cenere estraibile  
Removable ash tray



• Piano vetrificato (optional)  
Oberflächenverglasung  
Vitrified cooking plate  
Peut l'avoir vitrifié  
Placa vitrificada



• Cerchi in ghisa (optional)  
Kochringen aus Gusseisen  
Cast iron rings  
Cercles en fonte  
Circulos de hierro fundido



• Corrimano laterale sx o dx, 1pz (optional)  
Seitenhandlauf, rechts oder links, 1 Stück  
Lateral handrail, on right or left side, 1 piece  
Main courante latérale, gauche ou droite, 1 pièce  
Pasamanos lateral, derecho o izquierdo, 1 pieza

Beige



Cuoio



Bordeaux

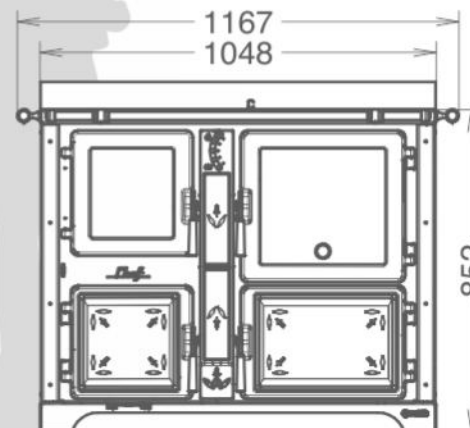

Chef 852x600x676  
Chef-F 852x1048x676

mm

16,4 kW

12,1 kW NOM.

3,7

Chef 227  
Chef-F 317

Kg

H x L x P  
320x340x515



Chef

Chef-F

**BOSKY**

silent



## Chef-F maiolica vintage

- ITA Dall'esperienza acquisita da più di 40 anni nella produzione di termocucine a legna abbiamo realizzato la cucina CHEF, con prestazioni ed emissioni sorprendenti. Un prodotto ecologico che primeggia nella sua categoria per le sue caratteristiche uniche.
- DEU Die Erfahrung aus mehr als 40 Jahren in der Produktion von Scheitholzküchenherd Wassergeführt, haben wir den Küchenherd CHEF realisiert, der mit erstaunlichen Arbeitsleistungen und niedrigen Emissionen, ist der erste Produkt in seiner Klasse.
- ENG If you want the best in wood fired cooking, this is it. High technology, Thermorossi ingenuity and all the experience gained in over 40 years of cooker manufacturing have gone into the production of our latest range of cookers and we are proud to introduce the Bosky Chef.
- FRA La cuisinière CHEF, avec ses prestations et ses émissions surprenantes, naît de l'expérience acquise par plus de 40 ans de production de thermo-cuisinières à buches: ce produit est la première cuisinière à buches de sa catégorie.
- ESP De la experiencia adquirida en más de 40 años de producción de termo cocinas de leña ha nacido el producto de cocina Chef, de eficiencias y emisiones admirables, que la destacan como el producto estrella de su categoría.

# Chef maiolica vintage

Uscite fumi disponibili: posteriore - superiore  
Flue outlet options: rear - top

Piano cottura in acciaio inox.  
Optional: Serie di cerchi  
in ghisa e piano vetrificato.  
Stainless steel cooking plate.  
Optional: cast iron rings  
and vitrified cooking plate

Corrimano laterale (optional)  
Lateral handrail (optional)

Ampio focolare  
(HxLxP-376x266x416)  
Large combustion chamber  
(HxLxD-376x266x416)

Maniglia antiscottatura  
Cool touch door handle

Preziosa maiolica artigianale  
fatta a mano  
Precious handmade majolica  
by master craftsmen

Tecnologia «easy cleaning»  
«Easy cleaning» technology

Aria primaria  
Primary air control

Aria secondaria  
Secondary air

Ampio cassetto cenere estraibile  
Removable ash tray

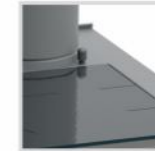

• Piano vetrificato (optional)  
Oberflächenverglasung  
Vitrified cooking plate  
Peut l'avoir vitrifié  
Placa vitrificada

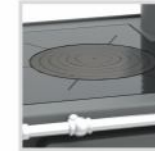

• Cerchi in ghisa (optional)  
Kochringen aus Gusseisen  
Cast iron rings  
Cercles en fonte  
Circulos de hierro fundido



• Corrimano laterale sx o dx, 1pz (optional)  
Seitenhandlauf, rechts oder links, 1 Stück  
Lateral handrail, on right or left side, 1 piece  
Main courante latérale, gauche ou droite, 1 pièce  
Pasamanos lateral, derecho o izquierdo, 1 pieza

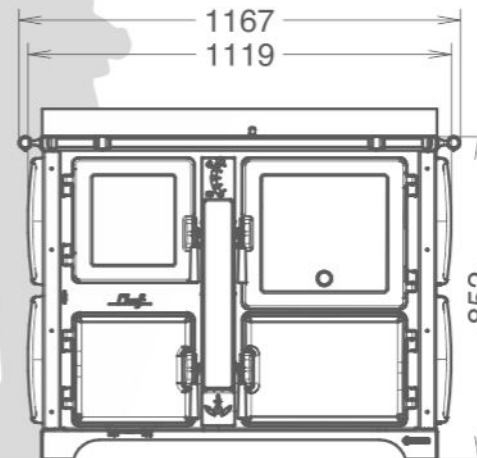
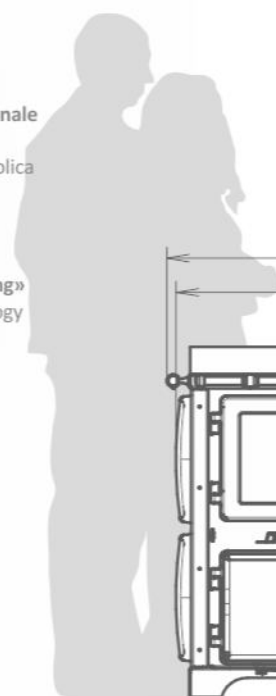

Chef 852x677x676  
Chef-F 852x1119x676



16,4 kW



12,1 kW NOM.



3,7



Chef 236  
Chef-F 327



H x L x P  
320x340x515





# Ardhea maiolica

- ITA** Progettata seguendo le recenti normative di sicurezza e costruzione europee, questo prodotto rappresenta la massima tecnologia ottenuta dopo 40 anni di esperienza nella produzione di caldaie e termocucine a legna. Collegata all'impianto idraulico di casa Ardhea riscalda l'intera abitazione e arreda grazie alle finiture curate.
- DEU** Entwickelt nach den neuesten Sicherheitsstandards und der Normen Europas, ein Produkt der Spitzentechnologie, entstanden auch mit den 40 Jahren Erfahrung in der Produktion von Heizkesseln und Heizungskuechenherd. Über die hydraulischen Anlage heizt Ardhea das ganze Haus, und moebliert mit ihren Details.
- ENG** Designed according to the more recent and restrictive european normatives concerning manufacturing and safety, this product represents the top of technology achieved after 40 years of experience in the production of wood boilers and central heating cookers. Connected to central heating system Ardhea warms the all house and furnishes it with style thanks to painstaking trimmings.
- FRA** Projetée selon les dernières normes de sécurité et construction européenne, ce produit représente la plus haute technologie obtenus après 40 années d'expérience dans la production de Thermo-cuisinières et à bois. Connecté à l'installation de chauffage Ardhea chauffe toute la maison et grâce à ses finitions soignées dans le même temps la fournit.
- ESP** Diseñada según las más estrechas normativas Europeas por la técnica de producción y la seguridad, este producto representa el máximo de la tecnología adquirido después de 40 años de experiencia en la producción de calderas de leña y termocucinas. Conectada al sistema de calefacción central, Ardhea calienta toda la vivienda y la ambla gracias a su diseño y a sus cuidados acabados. mente adelantado, gracias a la calidad selecta de los materiales y a las soluciones técnicas.

# Ardhea easy

Termometro caldaia, spia pompa, termostato anti-condensa.  
Boiler temperature sensor, pump allarmlight, anticondensation thermostat.



Ampio focolare  
(HxLxP-430x420x430)  
Large combustion chamber  
(HxLxD-430x420x430)

Maniglia antiscottatura  
Cool touch door handle

Ampio cassetto cenere estraibile  
Removable ash tray

Regolatore automatico di tiraggio  
Automatic draft control



• Scambiatore di sicurezza (optional)  
Sicherheitswärmetauscher  
Safety heat exchanger  
Échangeur de sécurité  
Intercambiador de seguridad



• Thermosole® 2.0 e 2.6 (optional)  
collettore solare;  
Solarkollektoren;  
Solar heating unit;  
Panneau solaire;  
Placa solar;



• Thermopuffer e Thermocell® (optional)  
accumuli a stratificazione;  
Thermisch geschichtete Pufferspeichern;  
Stratification thermal stores;  
Ballons d'accumulation à stratification;  
Acumuladores por estratificación;

Easy

Bianco

Beige

Cuoio

Bordeaux

1171x592x646



30,8



23



19



3,7



7,5



Easy 209  
Maiolica 236

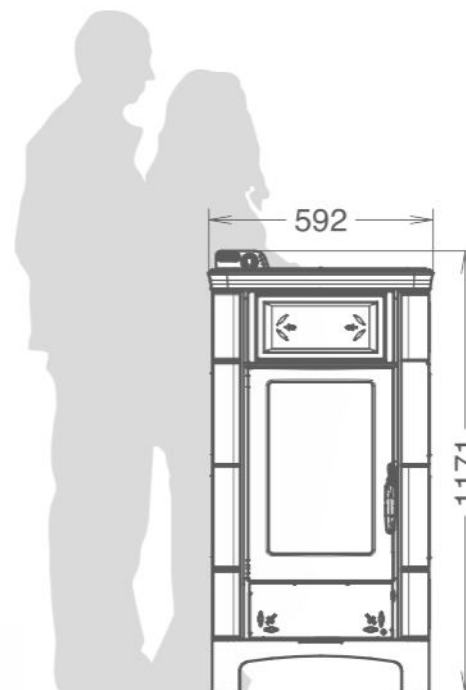



# Ardhea-F maiolica

**ITA** Progettata seguendo le recenti normative di sicurezza e costruzione europee, questo prodotto rappresenta la massima tecnologia ottenuta dopo 40 anni di esperienza nella produzione di caldaie e termocucine a legna. Collegata all'impianto idraulico di casa Ardhea riscalda l'intera abitazione e arreda grazie alle finiture curate, oltre a cucinare nella versione con forno.

**DEU** Entwickelt nach den neuesten Sicherheitsstandards und der Normen Europas, ein Produkt der Spitzentechnologie, entstanden auch mit den 40 Jahren Erfahrung in der Produktion von Heizkesseln und Heizungskuechenherd. Über die hydraulischen Anlage heizt Ardhea das ganze Haus, und moebliert mit ihren Details.

**ENG** Designed according to the more recent and restrictive european normatives concerning manufacturing and safety, this product represents the top of technology achieved after 40 years of experience in the production of wood boilers and central heating cookers. Connected to central heating system Ardhea warms the all house, furnishes it with style thanks to painstaking trimmings and, if equipped with oven, can also cook.

**FRA** Projetée selon les dernières normes de sécurité et construction européenne, ce produit représente la plus haute technologie obtenus après 40 années d'expérience dans la production de Thermo-cuisinières et à bois. Connecté à l'installation de chauffage Ardhea chauffe toute la maison et grâ- ce au ses finitions soignées dans le meme temps la fournit.

**ESP** Diseñada según las más estrechas normativas Europeas por la técnica de producción y la seguridad, este producto representa el máximo de la tecnología adquirido después de 40 años de experiencia en la producción de calderas de leña y termococinas. Conectada al sistema de calfacción central, Ardhea calienta toda la vivienda y La amobla gracias a su diseño y a sus cuidados acabados. Posibilidad de cocinar con el horno con que está equipada la versión "F".



# Ardhea-F easy

Termometro caldaia, spia pompa, termostato anti-condensa.  
Boiler temperature sensor, allarmlight pump, anticondensation thermostat.



Forno smaltato completo di griglia e leccarda (HxLxP-280x340x400)  
Enamelled oven complete with grill and dripping pan (HxLxP-280x340x400)

Ampio focolare (HxLxP-430x420x430)  
Large combustion chamber (HxLxD-430x420x430)

Maniglia antiscottatura  
Cool touch door handle

Ampio cassetto cenere estraibile  
Removable ash tray

Regolatore automatico di tiraggio  
Automatic draft control



• Scambiatore di sicurezza (optional)  
Sicherheitswärmetauscher  
Safety heat exchanger  
Échangeur de sécurité  
Intercambiador de seguridad



• Thermosole® 2.0 e 2.6 (optional)  
collettore solare;  
Solarkollektoren;  
Solar heating unit;  
Panneau solaire;  
Placa solar;



• Thermopuffer e Thermocell® (optional)  
accumuli a stratificazione;  
Thermisch geschichtete Pufferspeichern;  
Stratification thermal stores;  
Ballons d'accumulation à stratification;  
Acumuladores por estratificación;

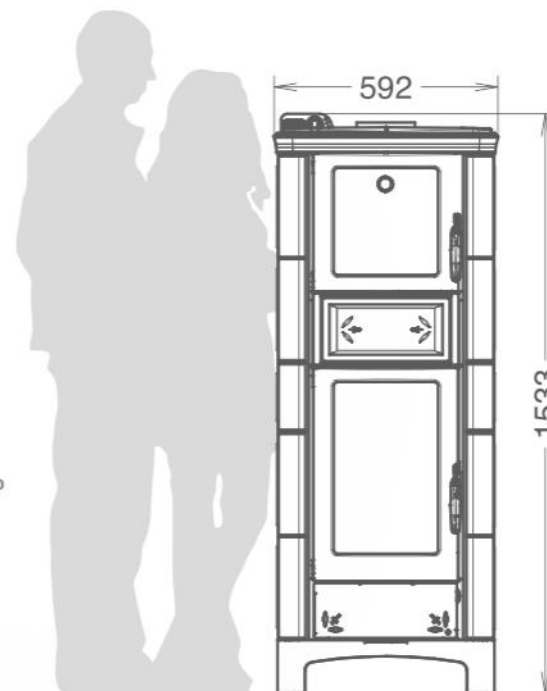

1533x592x646	mm
30,8	kW
23	kW NOM.
19	kW
3,7	kW
7,5	kW
Easy 261	Kg
Maiolica 297	Kg

H x L x P  
280x340x400





**BOSKY**



idra

## 25 e 30

- ITA Bosky dopo aver riscaldato le case di migliaia di affezionati clienti, oggi si rinnova nell'estetica mantenendo affidabilità e qualità. Il prezioso rivestimento in maiolica in rilievo nasconde un cuore tecnologicamente all'avanguardia per la qualità dei materiali e le esclusive soluzioni tecniche.
- DEU Nachdem der Bosky das Ambiente und die Wohnhäuser tausender Italiener eingeheizt und sie begeistert hat, zeigt er sich nun in neuer Verkleidung, behält aber Funktionalität und Zuverlässigkeit bei. Hinter der kostbaren Kachelverkleidung vom Bosky Heizherd, verbirgt sich ein technologisch fortschrittliches Herzstück, das sich durch die Qualität der eingesetzten Materialien und durch seine technischen Lösungen auszeichnet.
- ENG After having heated the homes of thousands of devoted customers BOSKY's appearance has been restyled while maintaining its renowned reliability and quality. The precious majolica covering of the Bosky central heating cooker hides a technological and advanced system.
- FRA Bosky, après avoir chauffé les maisons de milliers de clients fidèles, aujourd'hui elle s'est renouvelée esthétiquement en maintenant la fiabilité et la qualité. L'habillage précieux en faïence de la cuisinière Bosky cache un cœur technologiquement de pointe, grâce à la qualité de ses matériaux et aux solutions techniques.
- ESP Bosky, después de haber calentado las viviendas de miles de aficionados clientes, hoy se renova y se actualiza estéticamente conservando su fiabilidad y calidad. El precioso revestimiento en mayólica de la cocina térmica BOSKY encierra un corazón tecnológicamente adelantado, gracias a la calidad selecta de los materiales y a las soluciones técnicas.

Uscite fumi disponibili:  
posteriore - superiore  
Flue outlet options: rear - top

Stendino a scomparsa  
Foldaway drying rack



Sistema «smoke by-pass»  
«smoke by-pass» technology

Piano cottura in acciaio satinato.  
Optional: Serie di cerchi  
in ghisa e piano vetrificato  
Brushed steel cooking plate.  
Optional: cast iron rings  
and vitrified cooking plate

Focolare  
(HxLxD-540x300x442)  
Combustion chamber  
(HxLxD-540x300x442)

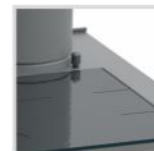

• Piano vetrificato (optional)  
Oberflächenverglasung  
Vitrified cooking plate  
Peut l'avoir vitrifié  
Placa vitrificada

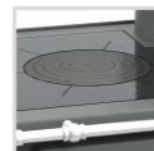

• Cerchi in ghisa (optional)  
Kochringen aus Gusseisen  
Cast iron rings  
Cercles en fonte  
Circulos de hierro fundido



• Scambiatore di sicurezza (optional)  
Sicherheitswärmetauscher  
Safety heat exchanger  
Échangeur de sécurité  
Intercambiador de seguridad



• INTEGRA TR-PACK (optional)  
Thermocell® (250/400/500 lt)  
Thermopuffer (400/500 lt)  
Thermosole® (2.0 e 2.6)

Bianco



Beige



Cuoio



Bordeaux



Canna di fucile



Bosky 25 - Bosky 30 - Corpo caldaia standard  
Bosky 25 - Bosky 30 - Corpo caldaia vetrificato

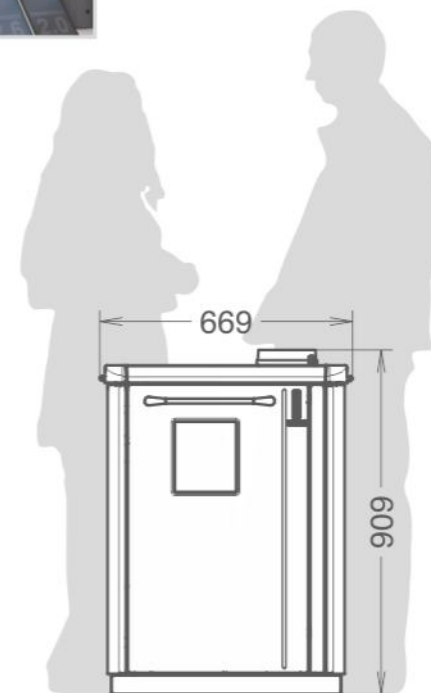

mm	mm	kW	kW NOM.	kW	kW	kg	kg
25	909x669x663	29,6	21	18	3,0	7,2	221
30	909x669x663	30,5	21,4	19	2,3	7,4	221

**BOSKY**



idra

## F-25 e F-30

ITA Bosky dopo aver riscaldato le case di migliaia di affezionati clienti, oggi si rinnova nell'estetica mantenendo affidabilità e qualità. Il prezioso rivestimento in maiolica in rilievo nasconde un cuore tecnologicamente all'avanguardia per la qualità dei materiali e le esclusive soluzioni tecniche.

DBU Nachdem der Bosky das Ambiente und die Wohnhäuser tausender Italiener eingeheizt und sie begeisterte, zeigt er sich nun in neuer Verkleidung, behält aber Funktionalität und Zuverlässigkeit bei. Hinter der kostbaren Kachelverkleidung vom Bosky Heizherd, verbirgt sich ein technologisch fortschrittliches Herzstück, das sich durch die Qualität der eingesetzten Materialien und durch seine technischen Lösungen auszeichnet.

ENG After having heated the homes of thousands of devoted customers BOSKY's appearance has been restyled while maintaining its renowned reliability and quality. The precious majolica covering of the Bosky central heating cooker hides a technological and advanced system.

FRA Bosky, après avoir chauffé les maisons de milliers de clients fidèles, aujourd'hui elle s'est renouvelée esthétiquement en maintenant la fiabilité et la qualité. L'habillage précieux en faïence de la cuisinière Bosky cache un cœur technologiquement de pointe, grâce à la qualité de ses matériaux et aux solutions techniques.

ESP Bosky, después de haber calentado las viviendas de miles de aficionados clientes, hoy se renova y se actualiza estéticamente conservando su fiabilidad y calidad. El precioso revestimiento en mayólica de la cocina térmica BOSKY encierra un corazón tecnológicamente adelantado, gracias a la calidad selecta de los materiales y a las soluciones técnicas.



Uscite fumi disponibili:  
posteriore - superiore  
Flue outlet options: rear - top

Focolare  
(HxLxP-540x300x442)  
Combustion chamber  
(HxLxD-540x300x442)

Piano cottura in acciaio satinato.  
Optional: Serie di cerchi  
in ghisa e piano vetrificato  
Brushed steel cooking plate.  
Optional: cast iron rings  
and vitrified cooking plate

Flap attivazione  
e regolazione forno  
Oven temperature  
control by smokes flap

Forno smaltato completo  
di griglia e leccarda  
(HxLxP-320x360x550)  
Enamelled oven complete  
with grill and dripping pan  
(HxLxD-320x360x550)

Stendino a  
scomparsa  
Foldaway  
drying rack

Regolatore automatico di tiraggio  
Automatic draft control

Leva di regolazione griglia  
Grate adjustment lever

Vano porta legna  
Wood storage pan

HxLxP  
320x360x550

Bosky F25 - Bosky F30 - Corpo standard  
Bosky F25 - Bosky F30 - Corpo vetrificato



• Piano vetrificato (optional)  
Oberflächenverglasung  
Vitrified cooking plate  
Peut l'avoir vitrifié  
Placa vitrificada



• Cerchi in ghisa (optional)  
Kochringen aus Gusseisen  
Cast iron rings  
Cercles en fonte  
Circulos de hierro fundido



• Scambiatore di sicurezza (optional)  
Sicherheitswärmetauscher  
Safety heat exchanger  
Échangeur de sécurité  
Intercambiador de seguridad



• INTEGRA TR-PACK (optional)  
Thermocell® (250/400/500 lt)  
Thermopuffer (400/500 lt)  
Thermosole® (2.0 e 2.6)

Bianco



Beige



Cuoio



Bordeaux



Canna di fucile

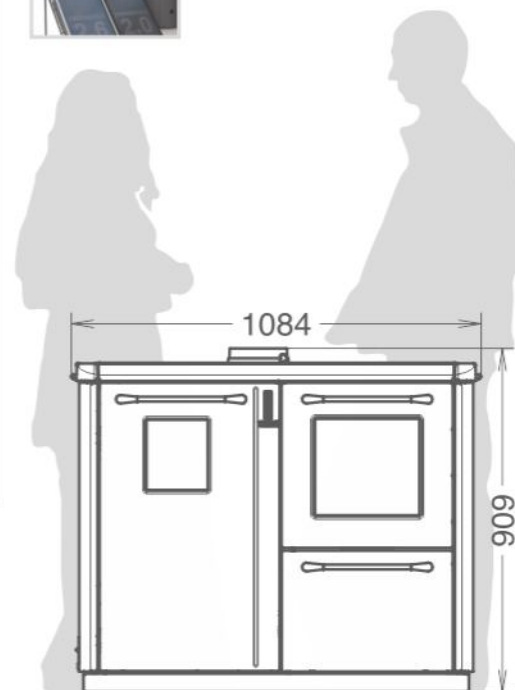

F25 909x1084x663  
F30 909x1084x663



F25 29,6  
F30 30,5



F25 21  
F30 21,4



F25 18  
F30 19



F25 3,0  
F30 2,3



F25 7,2  
F30 7,4



F25 304  
F30 304





**BOSKY**

idra

## Country-F fiori

**ITA** Bosky dopo aver riscaldato le case di migliaia di affezionati clienti, oggi si rinnova nell'estetica mantenendo affidabilità e qualità. Il prezioso rivestimento in maiolica in rilievo nasconde un cuore tecnologicamente all'avanguardia per la qualità dei materiali e le esclusive soluzioni tecniche.

**DEU** Nachdem der Bosky das Ambiente und die Wohnhäuser tausender Italiener eingeheizt und sie begeistert, zeigt er sich nun in neuer Verkleidung, behält aber Funktionalität und Zuverlässigkeit bei. Hinter der kostbaren Kachelverkleidung vom Bosky Heizherd, verbirgt sich ein technologisch fortschrittliches Herzstück, das sich durch die Qualität der eingesetzten Materialien und durch seine technischen Lösungen auszeichnet.

**ENG** After having heated the homes of thousands of devoted customers BOSKY's appearance has been restyled while maintaining its renowned reliability and quality. The precious majolica covering of the Bosky central heating cooker hides a technological and advanced system.

**FRA** Bosky, après avoir chauffé les maisons de milliers de clients fidèles, aujourd'hui elle s'est renouvelée esthétiquement en maintenant la fiabilité et la qualité. L'habillage précieux en faïence de la cuisinière Bosky cache un cœur technologiquement de pointe, grâce à la qualité de ses matériaux et aux solutions techniques.

**ESP** Bosky, después de haber calentado las viviendas de miles de aficionados clientes, hoy se renova y se actualiza estéticamente conservando su fiabilidad y calidad. El precioso revestimiento en mayólica de la cocina térmica BOSKY encierra un corazón tecnológicamente adelantado, gracias a la calidad selecta de los materiales y a las soluciones técnicas.

# Country fiori

Uscite fumi disponibili: posteriore - superiore  
Flue outlet options: rear - top

Piano cottura in acciaio satinato.  
Optional: Serie di cerchi in ghisa e piano vetrificato  
Brushed steel cooking plate.  
Optional: cast iron rings and vitrified cooking plate

Maniglia antiscottatura  
Cool touch door handle

Ampio focolare  
(HxLxP-520x300x442)  
Large combustion chamber  
(HxLxD-520x300x442)

Regolatore automatico di tiraggio  
Automatic draft control

Preziosa maiolica artigianale fatta a mano  
Precious handmade majolica by master craftsmen

Corrimano laterale (optional)  
Lateral handrail (optional)

Tecnologia «easy cleaning»  
«Easy cleaning» technology

XXL	Easy Cleaning	SMOKE BY-PASS	HxLxP 320x340x515				
							8 YEARS

Country - Corpo caldaia standard  
Country - Corpo caldaia vetrificato  
Country-F - Corpo caldaia standard  
Country-F - Corpo caldaia vetrificato

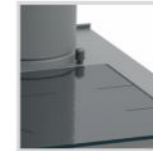

• Piano vetrificato (optional)  
Oberflächenverglasung  
Vitrified cooking plate  
Peut l'avoir vitrifié  
Placa vitrificada

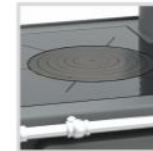
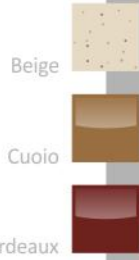

• Cerchi in ghisa (optional)  
Kochringen aus Gusseisen  
Cast iron rings  
Cercles en fonte  
Circulos de hierro fundido



• Corrimano laterale sx o dx, 1pz (optional)  
Seitenhandlauf, rechts oder links, 1 Stück  
Lateral handrail, on right or left side, 1 piece  
Main courante latérale, gauche ou droite, 1 pièce  
Pasamanos lateral, derecho o izquierdo, 1 pieza



• Scambiatore di sicurezza (optional)  
Sicherheitswärmetauscher  
Safety heat exchanger  
Échangeur de sécurité  
Intercambiador de seguridad



• INTEGRA TR-PACK (optional)  
Thermocell® (250/400/500 lt)  
Thermopuffer (400/500 lt)  
Thermosole® (2.0 e 2.6)

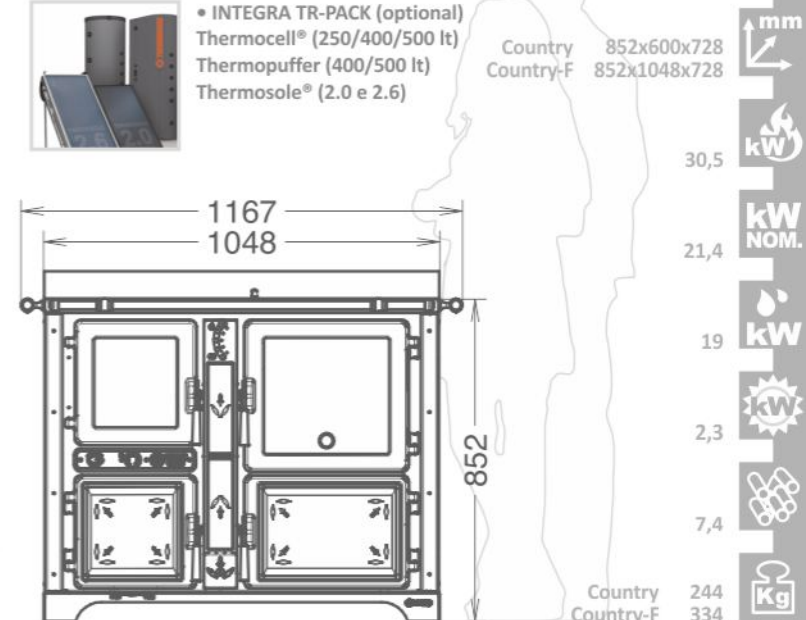

**BOSKY**



idra

## Country-F vintage

- ITA Bosky dopo aver riscaldato le case di migliaia di affezionati clienti, oggi si rinnova nell'estetica mantenendo affidabilità e qualità. Il prezioso rivestimento in maiolica in rilievo nasconde un cuore tecnologicamente all'avanguardia per la qualità dei materiali e le esclusive soluzioni tecniche.
- DEU Nachdem der Bosky das Ambiente und die Wohnhäuser tausender Italiener eingeheizt und sie begeistert hat, zeigt er sich nun in neuer Verkleidung, behält aber Funktionalität und Zuverlässigkeit bei. Hinter der kostbaren Kachelverkleidung vom Bosky Heizherd, verbirgt sich ein technologisch fortschrittliches Herzstück, das sich durch die Qualität der eingesetzten Materialien und durch seine technischen Lösungen auszeichnet.
- ENG After having heated the homes of thousands of devoted customers BOSKY's appearance has been restyled while maintaining its renowned reliability and quality. The precious majolica covering of the Bosky central heating cooker hides a technological and advanced system.
- FRA Bosky, après avoir chauffé les maisons de milliers de clients fidèles, aujourd'hui elle s'est renouvelée esthétiquement en maintenant la fiabilité et la qualité. L'habillage précieux en faïence de la cuisinière Bosky cache un cœur technologiquement de pointe, grâce à la qualité de ses matériaux et aux solutions techniques.
- ESP Bosky, después de haber calentado las viviendas de miles de aficionados clientes, hoy se renova y se actualiza estéticamente conservando su fiabilidad y calidad. El precioso revestimiento en mayólica de la cocina térmica BOSKY encierra un corazón tecnológicamente adelantado, gracias a la calidad selecta de los materiales y a las soluciones técnicas.



# Country vintage

Uscite fumi disponibili:  
posteriore - superiore  
Flue outlet options: rear - top

Corrimano laterale  
(optional)  
Lateral handrail  
(optional)

Ampio focolare  
(HxLxP-520x300x442)  
Large combustion chamber  
(HxLxD-520x300x442)

Regolatore automatico  
di tiraggio  
Automatic draft control

Piano cottura in acciaio satinato.  
Optional: Serie di cerchi  
in ghisa e piano vetrificato  
Brushed steel cooking plate.  
Optional: cast iron rings  
and vitrified cooking plate

Maniglia antiscottatura  
Cool touch door handle

Preziosa maiolica artigianale  
fatta a mano  
Precious handmade majolica  
by master craftsmen

Tecnologia «easy cleaning»  
«Easy cleaning» technology

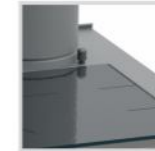

• Piano vetrificato (optional)  
Oberflächenverglasung  
Vitrificated cook  
Peut l'avoir vitrifié  
Placa vitrificada

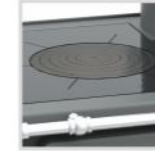

• Cerchi in ghisa (optional)  
Kochringen aus Gusseisen  
Cast iron rings  
Cercles en fonte  
Circulos de hierro fundido



• Corrimano laterale sx o dx, 1pz (optional)  
Seitenhandlauf, rechts oder links, 1 Stück  
Lateral handrail, on right or left side, 1 piece  
Main courante latérale, gauche ou droite, 1 pièce  
Pasamanos lateral, derecho o izquierdo, 1 pieza



• Scambiatore di sicurezza (optional)  
Sicherheitswärmetauscher  
Safety heat exchanger  
Échangeur de sécurité  
Intercambiador de seguridad



• INTEGRA TR-PACK (optional)  
Thermocell® (250/400/500 lt)  
Thermopuffer (400/500 lt)  
Thermosole® (2.0 e 2.6)

Bianco

Beige

Bordeaux

HxLxP 320x340x515					
XXL	Easy Cleaning	SMOKE BY-PASS	Italy	8 YEARS	
					Country - Corpo caldaia standard
					Country - Corpo caldaia vetrificato
					Country-F - Corpo caldaia standard
					Country-F - Corpo caldaia vetrificato

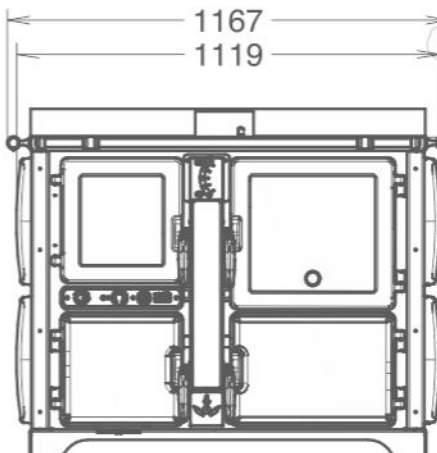
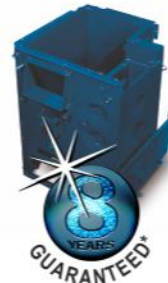

Country 852x677x728  
Country-F 852x1119x728



30,5

21,4

19

2,3

7,4

Country 253  
Country-F 344

# LEGENDA

ZEICHENERKLÄRUNG

LEGEND

LEGENDE

LEYENDA



mm

[mm] Misure (HxLxP)  
[mm] Abmessungen (HxBxT)  
[mm] Dimensions (HxWxD)  
[mm] Dimensions (HxLxP)  
[mm] Dimensiones (AxAxP)



kW

[kW] Potenza al focolare (min/max) (a)  
[kW] Feuerraumleistung (min/max) (a)  
[kW] Power to the heart (min/max) (a)  
[kW] Puissance au foyer (min/max) (a)  
[kW] Energia al hogar (min/max) (a)



kW  
NOM.

[kW] Potenza nominale (min/max) (a)  
[kW] Nennleistung (min/max) (a)  
[kW] Rated power (min/max) (a)  
[kW] Puissance nominale (min/max) (a)  
[kW] Potencia nominal (min/max) (a)



Kg

[kg] Peso  
[kg] Gewicht  
[kg] Weight  
[kg] Poids  
[kg] Peso



kW

[kW] Potenza resa per convezione e irraggiamento ambiente (a)  
[kW] Leistung übertragen für Konvektion und Ausstrahlung (a)  
[kW] Power rendered for convection and radiation to the atmosphere (a)  
[kW] Puissance rendue pour convection et rayonnement ambiant (a)  
[kW] Energia rendida para la convección y la radiación de la atmósfera (a)



kW

[kW] Potenza all'acqua (a)  
[kW] Leistung ans Wasser (a)  
[kW] Power to the water (a)  
[kW] Puissance a l'eau (a)  
[kW] Energia al agua (a)



kg/h

[kg/h] Consumo orario (min/max) (a)  
[kg/h] Stundlicher verbrauch (min/max) (a)  
[kg/h] Hourly consumption (min/max) (a)  
[kg/h] Consommation horaire (min/max) (a)  
[kg/h] Consumo horario (min/max) (a)

(a) Il dato varia in base al tipo e alla qualità di legna utilizzata.

(a) Die Daten hängen von der Art und Qualität des verwendeten Holz ab.

(a) Values can changes on the basis of wood used.

(a) Cette valeur peut changer suivant type et qualité des bûches utilisées.

(a) El dato declarado puede variar segundo el tipo de leña utilizada.

La ditta costruttrice si riserva di apportare modifiche senza preavviso. Der Hersteller behält sich das Recht vor, Änderungen ohne vorherige Ankündigung vorzunehmen.

The manufacturer reserves the right to make changes without previous notice.

Le fabricant se reserve d'apporter des modifications sans préavis.

El productor se reserva el derecho de aportar modificaciones sin preaviso.

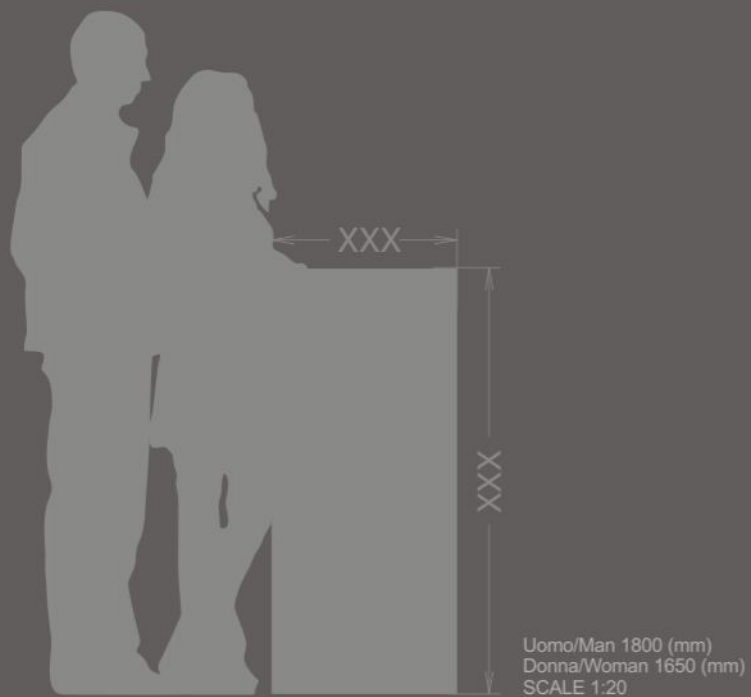

Prima dell'acquisto, richiedete al Vostro rivenditore tutte le informazioni relative all'installazione dell'apparecchio (vedi manuale d'uso)  
Vor dem Kauf erfragen Sie bitte bei Ihrem Händler alle Informationen zur Installation des Gerätes (siehe Betriebsanleitung)  
Before purchasing the appliance ask your reseller for all the relevant information concerning its installation (see user's guide)  
Avant l'achat, demander à votre revendeur toutes les informations nécessaires pour l'installation de l'appareil (voir manuel pour l'utilisation)  
Antes de adquirir el aparato, soliciten al vendedor todas las informaciones para su instalación (véase el manual de uso)

# THERMOROSSI

*Fire Lovers*

Seguici su:  
Find us on:



THERMOROSSI S.p.A.  
Via Grumolo, 4 (Z.I.)  
36011 Arsiero (VI) - ITALY  
[www.thermorossi.com](http://www.thermorossi.com)  
[info@thermorossi.it](mailto:info@thermorossi.it)



Numero Verde  
**800-448877**

Per conoscere il punto  
vendita a voi più vicino.

Worldwide - Phone: 0039.0445.741310 - e-mail: [export@thermorossi.it](mailto:export@thermorossi.it)